



**TAMIL NADU POWER GENERATION CORPORATION LIMITED
TUTICORIN THERMAL POWER STATION**

**SUPPLY OF ECO HOPPER ASH DISPOSAL PIPE LINES & FITTINGS FOR UNIT - V
SPECIFICATION FOR
PROCUREMENT / ~~WORKS CONTRACT~~ / ~~SERVICE CONTRACT~~
THROUGH E-TENDERING**

(Through NIC Platform)

SPECIFICATION NO. CE / TTPS - 4135 -S / 2025-26

OPENING DUE ON 17.04.2026

OPEN TENDER / TWO PART SYSTEM

**OFFICE OF THE CHIEF ENGINEER
TUTICORIN THERMAL POWER STATION
TUTICORIN - 628 004
TAMIL NADU.**

**Service Provider: The Tamil Nadu Government e-Procurement System
Website for online bid submission: <https://tntenders.gov.in/nicgep/app>**

INSTRUCTION TO BIDDERS FOR SUBMISSION OF ONLINE BIDS IN E-TENDER

The bidding under this contract is electronic bid submission through website <https://tntenders.gov.in/nicgep/app> only. Detailed guidelines for viewing bids and submission of online bids are given on the website. Any citizens or prospective bidders can logon to this website and view the invitation for Bids and can view the details of works for which bids are invited.

REGISTRATION:

- 1) The prospective bidders can submit bids online, however, the bidders are required to have enrolment/registration in the website by clicking on the link "Online bidder enrolment" which is free of charge.
- 2) As part of the enrolment process, the bidders are required to choose a unique username and assign a password for their accounts.
- 3) Bidders are advised to register their valid email address and mobile numbers as part of the registration process. These details would be used for any communication from the e-Portal.
- 4) Upon enrolment, the bidders are required to **register their valid Digital Signature Certificate (DSC)** (Class II or Class III Certificates with signing key usage) issued by any Certifying Authority recognized by CCA India (e.g. Sify / nCode / eMudhra etc.), with their profile.
- 5) Only one valid DSC should be registered by a bidder. Please note that the bidders are responsible to ensure that they do not lend their DSC's to others which may lead to misuse.
- 6) Bidder then can login to the site through the secured login by entering their user ID / password and the password of the DSC / e-Token.
- 7) **Correspondence details** : For queries related to registration and online bidding (NIC):

e-mail : support.etender@nic.in
Contact No. : 044 – 24466495
24902580 Extn:332
24917850

SEARCHING FOR TENDER DOCUMENTS

- 1) There are various search options built in the Website, to facilitate bidders to search active tenders by several parameters. These parameters could include Tender ID, organization name, location, date, value, etc.
- 2) Once the bidders have selected the tenders they are interested in, they may download the required documents/tender schedules. These tenders can be moved to the respective 'My Tenders' folder. This would enable the Tamil Nadu Govt. e-Procurement Portal, to intimate the bidders through SMS / e-mail in case there is any corrigendum issued to the tender document.
- 3) The bidder should make a note of the unique Tender ID assigned to each tender, in case they want to obtain any clarification / help from the Helpdesk.

PREPARATION OF BIDS

- 1) Bidder should take into account any corrigendum published on the tender document before submitting their bids.

2) Bidders are requested to go through the NIT and the tender document carefully to understand the documents required to be submitted as part of the bid. Please note the number of covers in which the bid documents have to be submitted, the number of documents including the names and content of each of the document that need to be submitted. Any deviations from these may lead to rejection of the bid.

3) Bidder, in advance, should get ready the bid documents to be submitted as indicated in the tender document and generally, they can be in PDF / XLS / RAR / DWF/JPG formats. **Bid documents may be scanned with 100 dpi with black and white option which helps in reducing size of the scanned document.**

4) To avoid the time and effort required in uploading the same set of standard documents which are required to be submitted as a part of every bid, a provision of uploading such standard documents (e.g. PAN card copy, annual reports, auditor certificates etc.) has been provided to the bidders. Bidders can use "My space or "Other Important Documents" area available to them to upload such documents. These documents may be directly submitted from the "My Space" area while submitting a bid, and need not be uploaded again and again. This will lead to a reduction in the time required for bid submission process.

5) The completed bid comprising scanned copy of the proof for the payment of EMD or exemption from payment of EMD and necessary technical and commercial documents should be uploaded on the website along with signed and scanned copies of requisite certificates as are mentioned in the different sections in the tender document.

ELECTRONIC SUBMISSION OF BIDS:

The bidder shall submit online the requirements under qualification criteria and Technical Documents required and Price Schedule/BOQ. All the documents are required to be signed digitally by the bidder. After electronic online bid submission, the system generates a unique bid reference number which is time stamped. This shall be treated as acknowledgement of bid submission.

Procedure for submission of bids:

1) Bidder should log into the site well in advance for bid submission so that they can upload the bid in time i.e. on or before the bid submission time. Bidder will be responsible for any delay due to other issues.

2) The bidder has to digitally sign and upload the required bid documents one by one as indicated in the tender document.

3) Bidder has to select the payment option as "offline" to pay the EMD amount through RTGS/NEFT or by way of account transfer as applicable and enter details of the instrument.

4) The scanned copy of payment made through RTGS/NEFT or by way of account transfer towards EMD amount has to be uploaded. TNPGL shall not be responsible for any delay in uploading the proof of EMD by any mode.

5) A BOQ format for the price bid has been provided with the tender document to be filled by all the bidders. Bidders are requested to note that they should necessarily submit their financial bids in the BOQ format provided and no other format is acceptable. Bidders are required to download the BOQ file, open it and complete the coloured (Unprotected) cells with their respective financial quotes and other details (such as name of the bidder). No other cells should be changed. Once the

details have been completed, the bidder should save it and submit it online, without changing the file name. If the BOQ file is found to be modified by the bidder, the bid will be rejected.

6) The server time (which is displayed on the bidders' dashboard) will be considered as the standard time for referencing the deadlines for submission of the bids by the bidders, opening of bids etc. The bidders should follow this time during bid submission.

7) All the documents being submitted by the bidders would be encrypted using PKI encryption techniques to ensure the secrecy of the data. The data entered cannot be viewed by unauthorized persons until the time of bid opening. The confidentiality of the bids is maintained using the secured Socket Layer 128 bit encryption technology. Data storage encryption of sensitive fields is done. Any bid document that is uploaded to the server is subjected to symmetric encryption using a system generated symmetric key. Further this key is subjected to asymmetric encryption using buyers/bid openers' public keys.

8) The uploaded tender documents become readable only after the tender opening by the authorized bid openers.

9) Upon the successful and timely submission of bids, (i.e. after clicking "Freeze Bid submission" in the portal) the portal will give a successful bid submission message & a bid summary will be displayed with the bid no. and the date & time of submission of the bid with all other relevant details.

10) Department or Service Provider is not responsible for any failure such as a bad internet connection or power failure outside of their control. The bidder is responsible to ensure they have sufficient time to submit an electronic bid prior to closing date and time including the payment of any fees including the Bid security and getting e-receipt. In case of a failure in the system within the control of the service provider that may affect a bidding process, the contracting authority on his sole discretion will postpone the closing time at least 24 hours from the time of system recovery to allow bidders sufficient time to submit their bids.

11) The TNPGL may, at its discretion, extend the deadline for the submission of bids by amending the bidding document, in which case all rights and obligations of TNPGL and bidders subject to the previous deadline shall thereafter be subject to the deadline extended.

Late Bids:

The Electronic bidding system would not allow any late submission of bids after due date and time as per server time.

Modification and withdrawal of bids:

1) Bidders may modify their bids online before the deadline for submission of bids.

2) In case a bidder intends to modify his bid online before the deadline, the bidder need not make any additional payment towards the cost of bid processing. For bid modification and consequential re-submission, the bidder is not required to withdraw his bid submitted earlier. Modification and consequential re-submission of bids is allowed any number of times. The last modified bid submitted by the bidder within the bid submission time shall be considered as the bid. For this purpose, modification/withdrawal by other means will not be accepted. The bidder may withdraw his bid by uploading his request before the deadline for submission of bids, however, if the bid is withdrawn, the re-submission of the bid is not allowed.

3) No bid may be modified after the deadline for submission of Bids.

ASSISTANCE TO BIDDERS:

Any queries relating to the tender document and the terms and conditions contained therein should be addressed to the Tender Inviting Authority for a tender or the relevant contact person indicated in the tender.

1) Any queries relating to the process of online bid submission or queries in general may be directed to the [24x7 Central Public Procurement Portal Helpdesk](#).

TAMIL NADU POWER GENERATION CORPORATION LIMITED
SPECIFICATION NO. CE / TTPS - 4135-S / 2025-26

1	Tender Specification No.	CE / TTPS - 4135-S
2	Name of Work	Supply of ECO Hopper Ash Disposal Pipe Lines & Fittings for Unit - V
3	Quantity	As per Schedule-A
4	Method of Tender	Open E-Tender System /Two Part System (Online Part-I – Techno Commercial Bid and Part-II – Price Bid, through Website: https://www.tntenders.gov.in)
5	a) Earnest Money Deposit (EMD)	Rs.17,900/- (Rupees Seventeen Thousand and Nine Hundred only) to be paid through online payment gateway. The online payment Gateway has been enabled for TANGEDCO in TN Tenders portal (www.tntenders.gov.in). The payment for EMD will be carried out by the Bidders only through online payment mode.
	b) Permanent EMD	The PEMD of Rs.20 Lakhs or above deposited on or after 11.11.2021 alone is eligible for EMD exemption in this tender.
	c) Exempted categories	The exempted categories of tenderers as given in Section-I Micro and Small Enterprises located inside the state of Tamil Nadu are eligible for exemption of EMD against submission of documents as detailed in Section-I.
6	URL for online bid submission for e-tender	13.03.2026 https://tntenders.gov.in
7	Last date for submission of EMD	16.04.2026 upto 14.00 Hrs. (The EMD amount has to be received before closing time of tender submission)
8	Date of closing of online e-tender for submission of Techno Commercial Bid & Price Bid.	16.04.2026 upto 14.00 Hrs.
9	Date & time of opening of tender electronically	17.04.2026 @ 14.30 Hrs.
10	Specification at website	The tender specification will be placed at the following web sites. The prospective bidders may download the same. TANGEDCO web site (www.tangedco.gov.in) TN Govt. Website (www.tenders.tn.gov.in) & https://tntenders.gov.in The prospective bidders may download the same at free of cost.
11	Documents to be uploaded by the Tenderers during e-submission	e-Receipt / Evidence for PEMD / Evidence for exemption, Schedules B to J, annexures and other documents whichever is applicable to be uploaded.
12	Tenders during e-submission	The Superintending Engineer, Purchase & Administration, SPARES Division , Tuticorin Thermal Power Station, Tuticorin – 628 004.
13	Place at which tenders will be opened	Office of the Superintending Engineer, Purchase & Administration, SPARES Division , Tuticorin Thermal Power Station, Tuticorin – 628 004.

Remarks: If the due date for opening the tenders happens to be declared holiday, then the tender will be opened on the next working day, for which no prior intimation will be given.

TENDER SPECIFICATION No. CE/TTPS - 4135-S

SECTION	DESCRIPTION	Pages
SECTION - I	EARNEST MONEY DEPOSIT	8 -11
SECTION - II	BID QUALIFICATION REQUIREMENTS	12
SECTION - III	REJECTION OF TENDERS	13
SECTION - IV	INSTRUCTION TO TENDERERS	14-18
SECTION - V	COMMERCIAL	19-33
SECTION - VI	FORMATS	
Schedule - A	PRICE BID	34
Schedule - B	SCHEDULE OF MATERIALS AND DELIVERY PERIOD	35
Schedule - C	C1 - DEVIATION FROM TECHNICAL SPECN	36
	C2- DEVIATION FROM COMMERCIAL SPECN	37
Schedule - D	STATEMENT OF SUPPLY ORDERS EXECUTED / UNDER EXECUTION DURING THE PASTTHREE YEARS AS ON THE DATE OF TENDER OPENING	38
Schedule – E	DECLARATION FORM	39
Schedule - F	UNDERTAKINGFORPAYMENTOFDUESTOTNEB	40
Schedule – G	UNDERTAKING IN LIEU OF E.M.D.	41-42
Schedule - H	UNDERTAKING TOWARDS JURISDICTION OF LEGAL PROCEEDINGS	43
Schedule - I	(e-Tender) TENDER ACCEPTANCE LETTER	44
Schedule - J	DECLARATION TO BE SUBMITTED BY EVALUATED L1 BIDDER	45
Schedule - K	BANK GUARANTEE FOR EMD	48
SECTION - VII	TECHNICAL SPECIFICATION	49

SECTION – I
EARNEST MONEY DEPOSIT

1. Tenderer should pay the specified amount towards Earnest Money Deposit as follows:-
EMD: **Rs.17,900/- (Rupees Seventeen Thousand and Nine Hundred only)**
- 1.1 The Earnest Money Deposit specified above **to be paid through online payment Gateway mode.**
Scanned copy of the E-receipt duly reflecting the EMD Transaction shall be uploaded.
- 1.2 If submitting Earnest Money Deposit as BG/PEMD/Udyam (MSME) (as mentioned in the specification), then select the exempted from EMD payment as "YES". Then upload the EMD exemption documents only in "pdf" files.
- 1.3 After confirming the EMD paid amount / Exemption uploaded, then only the system /tender portal will allow to submit the technical and financial bids.
- 1.4 **Mode of Payment:**
 - a) **The online payment Gateway has been enabled for TANGEDCO in TN Tenders portal (www.tntenders.gov.in). All the payments for the tenders like Earnest Money Deposit will be carried out by the Tenderer only through online payment mode. The Earnest Money Deposit amount should be the exact amount and no excess or less amount should be transferred through online payment gateway services of State Bank of India (SBI). If excess or short, the tender status will be shown as invalid. The Earnest Money Deposit payment to be made only single payment.**
2. The Tenderers who are having valid Permanent EMD with TNPGL(erstwhile TANGEDCO /TNEB for an amount as mentioned below are exempted from payment of Earnest Money Deposit and are eligible to participate in the tender.
The PEMD of Rs.20 Lakhs or above deposited on or after **11.11.2021** alone is eligible for EMD exemption in this tender .If the Tenderer desires to become a Permanent E.M.D. holder, he is advised to deposit the required amount with the TANGEDCO as Permanent E.M.D. well in advance, obtain a certificate from the Financial Controller/Purchase and upload copy of the same along with the tender.
3. **Bank Guarantee (BG):**
 - a) The EMD in the form of Bank Guarantee (BG) with one year validity is also acceptable.
 - b) The Bank Guarantee towards EMD shall be in the form of an irrevocable Bank Guarantee on non-judicial stamp paper of value not less than Rs.500/- as per the proforma enclosed as Schedule K in Section VI of this specification obtained from any Nationalised bank/Scheduled bank of India or any reputed foreign bank having branches in India.
 - c) In case EMD is paid in the form of Bank Guarantee, Original Bank Guarantee should be submitted within 3 working days from the date of tender opening in addition to uploading soft copy of it in the tender portal.
 - d) The scanned copy of the BG shall be uploaded with the Bid.
 - e) The Bank Guarantee shall be valid for One year.
 - f) The scanned copy of the E-receipt duly reflecting the EMD Transaction shall be uploaded or the scanned copy of the Bank Guarantee should be uploaded by the bidder during submission of Techno-commercial bid failing which the offer will be summarily rejected.
 - g) The EMD will not carry any interest.
4. The Earnest Money Deposit will be auto refunded to the unsuccessful tenderers after intimation of the rejection / non-acceptance of their tender.

- 5.0 In respect of the successful tenderer, the EMD remitted by the firm will be carried over as part of the Security Deposit payable by the tenderer.
- 5.1 Any other mode of payment of EMD shall not be accepted towards EMD and the tenders shall be rejected if EMD is not paid in the Government portal.
- 5.2 If the offer is found to be bogus or false during evaluation, TNPGL could invoke the Bank Guarantee to recover the EMD on forfeiture.
Any other mode of payment of EMD other than on line payment/BG/PEMD shall not be accepted and the tenders shall be rejected if EMD is not paid in the prescribed manner.
6. **Exemption for payment of Earnest Money Deposit.**
- The following categories of Industries are exempted from payment of EMD subject to ensuring that the tendered item should be covered in their registration certificate showing the materials permitted to manufacture.
- i) **“Micro and Small Enterprises located within the state of Tamil Nadu are exempted from payment of Earnest Money Deposit against the production of a Copy of Udyam Registration certificate or any other valid registration certificate / proof as notified by the Government of India in respect of the items manufactured by them for participation in this tender and whenever it is deemed necessary, the TANGEDCO may inspect the unit and satisfy themselves with regard to verifying the credentials of the applicants on the line of activity pursued by such manufacturers, quality and production capacity and other relevant factors”.**
- ii. Departments of the Government of Tamil Nadu.
- iii. Undertakings and Corporations owned by the Government of Tamil Nadu.
- iv. Labour Contract Co-operative Societies registered within Tamil Nadu.
- v) **The Micro & Small Enterprises having provisional registration certificate are not eligible for exemption.**
- vi) **Bidders shall submit an undertaking in the form as per Schedule-G that they would pay penalty an amount equivalent to Earnest Money Deposit in the event of non – fulfillment or non – observance of any of the conditions stipulated.**

Note:

- 1. Central and other State Government Departments/ Undertakings and Corporations other than those in Tamil Nadu shall have to pay Earnest Money Deposit.**
- 2. The industries who are exempted from payment of EMD, subject to the enterprise registered under the ministry of MSME shall register itself under Udyam Registration.**
- 3. Only enterprises which comes under MICRO and SMALL categories are eligible for EMD exemption.**
- 4. The MSME Units located outside the State of Tamilnadu are not eligible for exemption from payment of EMD in TANGEDCO tenders against Udyam Registration Certificate even though registered in Udyam portal for tendered items.**

REGISTRATION OF MICRO, SMALL & MEDIUM ENTERPRISES BY COMPOSITE CRITERIA IN UDYAM REGISTRATION & GUIDELINES:

6.1 Classification of Enterprises:

As per the Ministry of Micro, Small and Medium Enterprises, GOI Notification No S.O 2119 (E) dt.26.06.2020 the enterprises are classified as:

- i) A Micro Enterprise**, where the investment in Plant and Machinery or Equipment does not exceed Rs. 1 Crore (one crore Rupees) and turnover does not exceed Rs. 5 Cr. (Rupees five Crore);
 - ii) A Small Enterprise**, where the investment in plant and machinery or equipment does not exceed Rs. 10 Cr. (Ten crore Rupees) and turnover does not exceed Rs. 50 Cr. (Rupees fifty Crore);
- and

- iii) **A Medium Enterprise**, where the investment in plant and machinery or equipment does not exceed Rs. 50 Cr. (Fifty crore Rupees) and turnover does not exceed Rs.250 Cr. (Rupees Two Hundred and Fifty crore).

6.2 Calculation of Turnover:

In calculation of turnover of an enterprises, Exports of goods or services or both, shall be excluded while calculating the turnover of any enterprise whether micro, small or medium, for the purpose of classification.

The turn over details certified by Chartered Accountant, along with the bid from the bidders whose turnover includes export proceeds, for ascertaining the turnover achieved on export of goods or services or both and included in the total turnover to be uploaded.

6.3 Calculation of Investment:

The Plant and machinery as assigned to the plant machinery in the Income Tax Rules, 1962 framed under the Income Tax Act, 1961 and shall include all tangible assets (other than land and building, furniture and fittings). The cost of certain items specified in the Explanation I to sub section (1) of section 7 of the Act shall be excluded from the calculation of the amount of Investment in Plant and Machinery.

The investment value in Plant and Machinery for the purpose has to be certified by a Chartered Accountant and the same is to be uploaded along with the bid in case the bidder claims EMD exemption.

- a) Central and the State Government Departments/ Undertakings and Corporations other than those in Tamil Nadu shall have to pay Earnest Money Deposit.

The Micro and Small Enterprises satisfying the composite criteria under reclassification notified by MSME with Udyam Registration Certificate for tendered item are only exempted from EMD payment.

Micro and Small Enterprises located outside Tamil Nadu are not eligible for exemption from payment of EMD in this tender against Udyam Registration certificate eventhough registered in Udyam portal for the tendered item.

7) DOCUMENTS TO BE UPLOADED AS A PROOF OF ELIGIBILITY FOR EXEMPTION FROM PAYMENT OF EARNEST MONEY DEPOSIT:

- I. Copy of **Udyam Registration Certificate**
- II. (a) **Copy of turnover details certified by Chartered Accountant.**
and
(b) **Copy of Investment held in Plant & Machinery certified by Chartered accountant should be furnished for availing payment of EMD exemption.**
- III. **Those tenderers under exempted category from payment of EMD shall enclose the Undertaking in lieu of EMD in the form as per Schedule-G duly filled up and signed in Rs.500/- Non Judicial Stamp Paper by the bidders as acceptance to pay as penalty an amount equivalent to EMD, together with cost if any, in the event of non-fulfillment or non-observance of any of the conditions stipulated in the contract consequent to such breach of contract.**

The Undertaking in lieu of EMD shall be submitted in original by the bidder after Tender Opening in addition to uploading of it in the Portal, failing which the offer is liable for rejection.

The State Government, Public Sector Undertakings who are exempted from payment of EMD should also pay as penalty an amount equivalent to the amount fixed as Security Deposit in the event of non-fulfillment or non-observance of any of the conditions stipulated in the contract.

8) CONDITIONS FOR REJECTION OF BIDS OF EXEMPTION CATEGORIES:-

- i) If the documentary evidences towards Exemption from payment of EMD are not uploaded

- ii) Exempted Tenderers are to produce copy of their Registration Certificate showing the materials which they are permitted to MANUFACTURE and the PERIOD OF VALIDITY OF CERTIFICATE.
- iii) Exemption of EMD is allowed to the units for those materials manufactured in their Units. If the tendered items are not on their manufacturing range, the tenderer cannot claim exemption from payment of EMD and such tenders will be rejected straight away.
- iv) If not furnished the details for Investment held in Plant and Machinery certified by Chartered Accountant and another certificate for Annual turnover value certified by Chartered Accountant.
- v) If not furnished the Undertaking in lieu of EMD specified under Sl.No.8 (III).

9) The following should be uploaded by the Vendor during submission of Techno commercial bid for payment of EMD failing which the offer will be SUMMARILY REJECTED.

The proof of Permanent EMD certificate / Bank Guarantee details and undertaking in lieu of EMD in the format as per schedule - G.

(OR)

The proof for exemption of EMD and certificate towards Investment held in plant & machinery and certificate for Annual turnover certified by Chartered Accountant.

10) REFUND OF EMD:

- (i) The Earnest Money Deposit will be refunded automatically to the unsuccessful tenderers after intimation of the rejection / non-acceptance of their tender. i.e. after technical evaluation.
- (ii) The Earnest Money Deposit will be refunded automatically to the eligible tenderer who have not received the detailed Purchase order. i.e. after issue of Award Of Contract.
- (iii) The Earnest Money Deposit will be transferred to TNPGL account in the case of successful tenderer on receipt of detailed Purchase Order and will not carry any interest. The Earnest Money Deposit will be adjusted in the Security cum Performance Guarantee.
- (iv) The refund of EMD will be made to the bank account from which EMD is paid by the bidder through portal.

11) The Earnest Money Deposit / Permanent EMD made by Tenderer will be forfeited on the following conditions :

- i) If he withdraws his tender or backs out after acceptance of the tender or fails to remit the Security deposit.
- ii) If he revises any of the terms quoted during the validity period.
- iii) If he violates any of the conditions of the Tender specification.
- iv) If, the documents furnished with the offer being found to be bogus or the documents contain false particulars.
- v) If, the successful tenderer failing to execute the order placed on them to the satisfaction of the TNPGL Limited.
- vi) In case of tenderers participating on the strength of Exception Categories, an amount equivalent to the EMD for this specification will stand forfeited in the event of such tenderer committing any one of the acts listed above.
- vii) If the Bid Qualification Requirements are found to be fraudulent/ non-genuine, the EMD paid will be forfeited in addition to black listing in future contracts with TNPGL.

12) In respect of the successful tenderer, the EMD remitted by the bidder will be carried over as part of the security deposit payable by the tender. Successful tenderer who had participated in the tenders upon PEMD will have to remit the full amount of security Deposit required for individual contracts.

SECTION – II
SPECIFICATION
BID QUALIFICATION REQUIREMENTS (BQR)

The Bidders shall become eligible to bid on satisfying the following Bid Qualification Requirements and uploading of the required documentary evidences.

Required evidence for the following BQR conditions should be furnished along with the tender. Otherwise the offer will be summarily rejected.

1. The Tenderer should have previously supplied SS pipe fittings / any SS fabricated materials for sea water application in Ash Handling Plant to any Thermal Power Station with a capacity of 210MW as a Single Unit or above of State / Central Government Organizations, Public Sector undertakings in India for a value of not less than **Rs.5.60 Lakhs in a single order** and the same should have been in satisfactory service for a minimum period of one year from the date of utilization as on the date of Tender opening.**The bidder should upload the relevant Purchase Order.**

The bidder should upload photo copies of the orders for having done the supply and the End User certificate for the satisfactory performance of the same. In case, the above order was executed in TNPGL (formerly TANGEDCO)/TNEB, the End user certificate shall be obtained by the Tender Inviting Authority directly from the concerned station. However in case of other organizations, End user certificate should be obtained and uploaded by the bidder along with the offer, otherwise the offer will be rejected.

2. The Annual Turn Over of the Tenderer should not be less than **Rs.5.60 Lakhs** in any one of the preceding three financial years (ie) **(2021-22, 2022-23 & 2023-24)**. The bidders should upload the following evidences **for annual turnover for all the three said financial years.**

In case of companies registered under Companies Act, the **copy** of the Audited Financial Statements like, P & L Account and Balance Sheet for all the above 3 years may be **scanned and uploaded** and in case of others, the **copy** of Annual Turn Over certified by practicing Chartered Accountant for all the above 3 years may be **scanned and uploaded** as documentary proof to ensure the turnover criteria. The Audited Annual Accounts, Annual Turn over issued by Chartered Accountant should necessarily contain UDIN of the document.

SECTION – III
REJECTION OF TENDERS

- I. Tenders will be SUMMARILY rejected if:
- a). The EMD requirements are not complied with.
 - b). If the bids are received through Consortium or Joint venture, the same will not be considered and the bids will be rejected.
 - c). The Bid Qualification Requirements as per Section-II of this Specification are not satisfied.
- II. Tender is LIABLE to be rejected, if it is:
- a). Not covering the entire scope of supply of materials.
 - b). If the declaration as specified in Schedule E (Declaration Form) & I (Tender Acceptance Letter (e-Tender) is not signed and enclosed.
 - c). With validity period less than that stipulated in this specification.
 - d). Not in conformity with Tnpgcl's Commercial terms and Technical Specifications (Section - V & VII).
 - e). Received from a tenderer who is directly or indirectly connected with Government service or Board Service or services of local authority.
 - f). From any black listed Firm or Contractor.
 - g). Received by Telex / Telegram / E-Mail/ Fax /Post.
 - h). From a tenderer whose past performance / Vendor rating is not satisfactory
 - i) Not containing all required particulars as per Schedule A to I.
 - j). Documents furnished by the Tenderers along with their offer being found to be bogus or contain false particulars.
 - k). The offer of bidders who have not furnished the GSTIN Number in the offers.
 - l) Received after tender opening.
 - m) Tender, which is incomplete, obscure or irregular.

SECTION – IV

SPECIFICATION NO. CE / TTPS -4135-S / 2025-26

INSTRUCTION TO TENDERERS

1.0. **THE TAMIL NADU TRANSPARENCY IN TENDERS ACT 1998:**

- 1.1 The Tamil Nadu Transparency in Tenders Act 1998 and the Tamil Nadu Transparency in Tender Rules 2000 and subsequent amendments thereof are applicable to this tender.
- 1.2. THE TENDERERS WHO DO NOT FULLFILL THE "BID QUALIFICATION REQUIREMENT" AS PER SECTION-II NEED NOT PARTICIPATE IN THE TENDER. OFFERS NOT SATISFYING THIS "BID QUALIFICATION REQUIREMENTS" WILL NOT BE CONSIDERED AND WILL BE SUMMARILY REJECTED.
- 1.3. The terms 'tenderer', 'supplier', 'contractor' refer to Bidder. The terms 'Purchaser', 'Board' 'TNEB' refer to TNPGL.

2.0 **SCOPE OF SUPPLY:**

- 2.1 The Scope of supply (described in Schedule-A) is **Supply of ECO Hopper Ash Disposal Pipe Lines & Fittings for Unit - V** and delivery of the materials detailed herein, at TNPGL stores / TTPS/ TUTICORIN/Tamil Nadu.

Any supply/service which has not been specifically mentioned but is required for the complete fulfilment of Performance Guarantee shall also be supplied by the bidder.

Tamil Nadu Transparency in Tenders Act 1998 and the Tamil Nadu Transparency in Tender Rules 2000 and subsequent amendments thereof are applicable to this Tender.

3.0 **SUBMISSION OF TENDER OFFER:**

- 3.1 The tenderer is expected to examine all instructions, Schedules and Annexure detailed in the Specification and submit the Schedule of Prices and other required particulars in the Schedules and Annexures called for in this Specification, only as per the formats prescribed herein.

4.1 **SUBMISSION OF TENDERS:**

- 4.1.1. The Tender Offer consisting of Schedules-A to I should be filled up and signed by the Tenderer or any person holding Power of Attorney authorizing him to sign on behalf of the Tenderer before submission of the Tender. The date of signature should invariably be indicated.
- 4.1.2. In the event of tender being submitted by other than a firm, it must be signed by a partner (copy of partnership deed should be enclosed) and in the event of the absence of any Partner, it shall be signed on his behalf by a person holding a Power of Attorney authorising him to do so, Certified copies of which shall be enclosed.
- 4.1.3. Tender submitted on behalf of companies registered under the Indian Companies Act, shall be signed by person duly authorised to submit the tender on behalf of the company and shall be accompanied by certified true copies of the resolutions, extracts of the Articles of Association, special or general Power of Attorney etc. to show clearly the title, authority and designation of persons signing the tender on behalf of the company.
- 4.1.4. The tenderer should furnish the GSTIN numbers in the offer.

4.2. **Modifications/Clarifications to Tender Documents:**

4.2.1. At any time after the commencement of e-Tender and before the closing of the event, TANGEDCO may make any changes, modifications or amendments to the tender documents and same will be intimated to the concerned Vendors through corrigendum which can be downloaded from the Vendor login.

4.2.2. In case any tenderer asks for a clarification to the tender documents before 48 hours of opening of tenders, the Chief Engineer/TTPS/Tuticorin will clarify the same.

4.2.3. If any tenderer raises clarifications after the opening of the tender, the clarified reply issued by the Chief Engineer/TTPS/Tuticorin on the clarifications will be final and binding on the Tender.

4.3. All tender offers shall be prepared by typing or printing in the formats enclosed with this specification.

4.4. All information in the tender offer shall be in ENGLISH only. It shall not contain interlineations, erasures or overwriting except as necessary to correct errors made by the tenderer. Such erasures or other changes in the tender documents shall be attested by the persons signing the tender offer.

4.5. **QUOTATION OF RATES:**

4.5.1. Rates should be quoted in both figures (i.e. integers) and words. In case of ambiguity between rates in figures and words, lower of the two will be taken for tender evaluation.

4.5.2. Offers giving lump sum price, without giving their breakup as per details required in the attached Price Schedule-A shall be liable for rejection.

4.6. **PRINTED TERMS AND CONDITIONS IN TENDERS:**

Supplier's printed terms and conditions will not be considered as forming part of the tender under any circumstances.

4.7. **INCOMPLETE TENDERS:**

Tender, which is incomplete, obscure or irregular is liable for rejection.

4.8. **AMBIGUITIES IN CONDITIONS OF TENDERS:**

In the case of ambiguous or contradictory terms / conditions mentioned in the bid, interpretation as may be advantageous to the purchaser may be taken without any reference to the Tenderer.

4.9. The tender offer shall contain full information asked for in the accompanying schedules and elsewhere in the specification.

4.10. Tenderers shall bear all costs associated with the participation in the e- Tender and the purchaser will in no case be responsible or liable for these costs.

4.11. No offer shall be withdrawn by the Tenderer in the interval between the deadline for submission and the expiry of the period of validity specified / extended validity of the tender offer.

4.12. The Tenderers are requested to furnish the exact location of their factories with detailed postal address and pin code, telephone and Fax Nos. etc. in their tenders so as to arrange inspection by the TANGEDCO, if considered necessary.

4.13. **DESTINATIONS-WHERE MATERIALS ARE REQUIRED:**

The prices quoted should be on FOR Destination basis for delivery at Central Stores/Tuticorin Thermal Power Station/Tuticorin-628004.

5.0. **TENDER OPENING:**

5.1. OPENING OF COMMERCIAL & TECHNICAL BIDS WITHOUT PRICE (PART-I):

The Tender offers except price Bid will be opened electronically at 14.30 Hrs. on the date notified at the Office of the Superintending Engineer, Purchase & Administration / (Executive Engineer /Spares)Tuticorin Thermal Power Station, Tuticorin-628004, through <https://tntenders.gov.in> Tenderers need not to visit TTPS office during tender opening, whereas tenderers can witness the tender opening event through their login.

5.2. If the last date set for submission of e-tender offers and opening date happens to be a holiday, the tenders will be received and opened on the succeeding working day without any changes in the timings indicated.

5.3. **OPENING OF THE PRICE BIDS:**

The date and time of opening of Price Bids shall be later notified through registered e-mail to the Bidders who fulfil the BQR criteria and whose bids are found to be commercially and technically acceptable.

6.0. **INFORMATION REQUIRED AND CLARIFICATIONS:**

6.1. In the process of examination, evaluation and comparison of tender offers, the TNPGL may at its discretion, ask the Tenderer for a clarification of their offers. All responses to requests for clarifications shall be in writing to the point only. No change in the price or substance of the offer shall be permitted.

6.2. The TNPGL will examine the tender offers to determine whether they are complete, whether any computational errors have been made, whether required sureties have been furnished, whether the documents have been properly signed and whether the offers are generally in order.

6.3. The Tender offers shall be deemed to be under consideration immediately after they are opened and until such time official intimation of award / rejection is made by the Tender Accepting Authority to the tenderers.

6.4 The Tenderers shall not make attempts to establish unsolicited and unauthorized contact with the Tender Inviting Authority, Tender Accepting Authority or Tender Scrutiny Committee after the opening of the tender and prior to the notification of the award and any attempt by any tenderers to bring to bear extraneous pressures on the Tender Accepting Authority shall be sufficient reason to disqualify the tenderer.

6.4 Mere submission of any Tender offer connected with these documents and Specification shall not constitute any agreement. The tenderer shall have no cause of action or claim, against the TNPGL for rejection of their offer, except as mentioned in Clause-10.0 of Section-IV. The TNPGL shall always be at liberty to reject or accept any offer or offers at its sole discretion and any such action will not be called into question and the Tenderer shall have no claim in that regard against the TNPGL.

7.0. **EVALUATION AND COMPARISON OF THE TENDER OFFERS:**

7.1. The tenders will be evaluated strictly as per the Tamil Nadu Transparency in Tenders Act, 1998 and the Tamil Nadu Transparency in Tender Rules, 2000 and its subsequent amendments till date.

7.2. The tender offers received will be examined to determine whether they are in complete shape, all required Data have been furnished, properly signed and generally in order and conforms to all the terms and conditions of the Specification without any deviation.

7.3. For the purpose of evaluation of tender offers, the following factors will be taken into account for arriving the evaluated price:

- * ***The quoted price will be corrected for arithmetical errors.***
- * ***The rate of CGST, SGST, and IGST as applicable both in percentage and amount shall be indicated in the offer along with HSN code.***
- * ***The evaluated price shall be arrived in compliance with the provisions of GST on the Transaction value i.e. (Ex works price + P&F+ Freight and Insurance) + GST. In case of import of goods would be treated as inter state supplies and would be subject to IGST in addition to applicable customs duty.***
- * ***Since GST is enacted wherein all taxes & duties are subsumed, price evaluation shall be inclusive of applicable GST in all cases, i.e. even if the bidders are only within the State or bidders are within the State and outside TN.***

8.0. **VALIDITY:**

- 8.1. The tender offer shall be kept valid for acceptance for a period of 180 days from the date of opening of offers. The offers with lower validity period are liable for rejection.
- 8.2. Further, the tenderer shall agree to extend the validity of the Bids without altering the substance and prices of their Bid for further periods, if any, required by the TNPGL

9.0. **RIGHTS OF THE BOARD:**

9.1. **Rights to reject the tenders:**

- 9.1.1. After negotiation with the Tenderer and before passing the order accepting a tender, if the Tender Accepting Authority decides that the price quoted by such tenderer is higher by the percentage as may be prescribed over the schedule of rates or prevailing market rates, the tender shall be rejected.
- 9.1.2. The Tender Accepting Authority before passing the order accepting a tender, may also reject all the tenders for the reasons such as changes in the scope of procurement, lack of anticipated financial resources, court orders, accidents or calamities and other unforeseen circumstances.

Notwithstanding anything contained in this Specification, the TNPGL reserves the rights:

- a). To recover losses, if any, sustained by TNPGL from the supplier who pleads his inability to supply and backs out of his obligation after award of contract. The security deposit paid shall, be forfeited.
 - b). To cancel the orders for not keeping up the delivery schedule.
 - c). To vary the delivery period based on the requirement and contingencies at the time of placing the order.
 - d). To accept the lowest eligible tender.
 - e). To reject any or all the tenders or cancel without assigning any reasons thereof.
 - f). To relax or waive or amend any of the conditions stipulated in the tender Specification wherever deemed necessary in the best interest of the TNPGL
- 9.2. The purchaser reserves the right to request for any additional information and also reserves the right to reject or accept the proposal of any tenderer, if in the opinion of the purchaser, the qualification data is incomplete or in the opinion of the TNPGL the bidder is found not qualified to satisfactorily perform the contract.

10.0. **DEVIATIONS:**

10.1. The offers of the Tenderers with Deviations in Commercial terms and Technical Terms of the Tender Document are liable for rejection.

11.0. **BAR OF JURISDICTION:**

Save as otherwise provided in the Tamil Nadu Transparency in Tenders Act 1998, no action taken by any officer or authority under this Act shall be called in question in any court, and no interminjection shall be granted by any court in respect of any action taken or to be taken by such officer or authority in pursuance of any power conferred by or under this Act.

12.0. **APPEAL:**

Any Tenderer aggrieved by the order passed by the Tender Accepting Authority under Section-10 of the Tamil Nadu Transparency in Tenders Act 1998 may appeal to the Government within 10 (Ten) days from the date of receipt of order.

13.0. **TENDER DOCUMENT:**

13.1. "All the intending e-tenderers are informed that in the event of the documents furnished with the offer being found to be bogus or the documents contain false particulars, the EMD paid by such tenderers will be forfeited in addition to blacklisting them for future tenders/ contracts in TANGEDCO" and also cancelling the award of contract issued to them."

SECTION - V
SPECIFICATION
COMMERCIAL

1.0. SCOPE:

- 1.1. The scope of supply of the materials includes manufacture, inspection, testing, packing, forwarding, insuring and delivery of the materials detailed herein, at TNPGL Stores in TTPS/Tuticorin/Tamil nadu.

2.0. DETAILS OF PURCHASE ORDERS ALREADY EXECUTED:

- 2.1. The tenderers shall furnish documentary evidence as stipulated in BQR vide Sec. II (BQR Conditions).

3.0 DETAILS OF PURCHASE ORDERS ALREADY EXECUTED:

- 3.1 The tenderers shall furnish documentary evidence as stipulated in BQR vide Sec. II (BQR Conditions).

4.0 PAST PERFORMANCE:

- 4.1 The intending tenderers shall furnish the details of various supply orders/work contracts executed by them for the past three years as on the date of Tendering in the proforma enclosed in the Tender Specification as per Schedule-D along with end user Certificate for satisfactory performance of the materials supplied.

- 4.2 The details furnished by the tenderers shall be in complete shape and if it is found that any information is found omitted, suppressed, incomplete or incorrect, the same will be taken note of while dealing with the Tenders in future. Tenders furnished by the tenderers without these accompanying details of their past performance are liable for rejection.

5.0 COMPLETENESS OF TENDER:

- 5.1 The tender should be complete with all details of illustrative and descriptive literature and drawings. The tenderers shall furnish the complete technical details of the equipment/materials. Information regarding the country of manufacture or origin of materials used in the manufacture of the articles should be furnished. The tenderer should include all minor accessories even though not specifically mentioned in this specification but which are essential for the completeness of the materials ordered. The tenderer shall not be eligible for extra charges in respect of such minor accessories though not included in the tender.

6.0 DEVIATIONS:

- 6.1 The offers of the Tenderers with Deviations in Commercial terms and Technical Terms of the Tender Document are liable for rejection.

7.0 EVALUATION:

- 7.1 The evaluation shall include GST applicable as a part of the price, as detailed below and Packing & Forwarding and Freight & Insurance charges.

- 7.2 In a tender where the tenderers are both from the State of Tamil Nadu as well as from outside the State of Tamil Nadu, the evaluation will be done based on the GST.

8.0 PLACING OF ORDERS:

- 8.1 The award of contract will be issued to the successful tenderer with all TNPGL Ltd's terms and conditions, duly indicating the approved unit rates and the quantity allotted to them. The approved rates will be FIRM.

9.0 PRICE:

- 9.1 The Tenderers are requested to quote FIRM price in Indian Rupees only.
- 9.2 The Tenderers shall quote the Ex-works price for supply and price for Erection works, Packing & Forwarding charges and Freight & Insurance charges with applicable rate of GST separately for Delivery to Tuticorin TPS Stores, Tuticorin, Tamil Nadu. A format for price schedule is given in Schedule 'A'.
- 9.3 The Freight and Insurance charges shall be applicable for delivery to Tuticorin TPS Stores, Tuticorin, Tamil Nadu.
- 9.4 The above breakup details should be clearly indicated in the Schedule-A and in the absence of which the offer shall be liable for rejection.

9.5) PERMANENT ACCOUNT NUMBER AND GSTIN NUMBER:

The Tenderer shall indicate the Permanent Account No. issued by the Government of India, Income Tax Department and GSTIN number of the firm and should enclose the same with the Tender.

The L1 bidder shall furnish the declaration in respect of passing of ITC benefit as per sec 171 of CGST Act as rebate in the price offered. In the event of L1 bidder, specifying the ITC benefit as Nil, the same shall be supported with certificate from chartered accountant. A format of declaration will be as stipulated by TNPGL.

9.6) RATES ARE INCLUSIVE OF INCIDENTAL ITEMS:

It will be deemed that the rates quoted by the tenderer are inclusive of all incidental items of work not necessarily mentioned in the schedule but nevertheless essential for the correct and complete execution of the work. The prices should be in Indian Currency.

No variation in price will be accepted and price quoted should be firm till the acceptance of the proposal furnished by the tenderer

The rates quoted for individual items shall be firm and exclusive of GST. The applicability of GST shall be enumerated separately.

10 Goods and Services Tax: (GST)

The GST Details in respect of TTPS / TNPGL are as under:

<i>Billing Address</i>	<i>The Superintending Engineer / Purchase and Administration TTPS / Tuticorin</i>
<i>Provisional GSTIN Registration No.</i>	<i>33AAKCT7598K1ZI</i>
<i>PAN</i>	<i>AAKCT7598K</i>
<i>Type of Customer</i>	<i>Company</i>
<i>Name & Address as Registered in GSTIN –Place of Business</i>	<i>Tamil Nadu Power Generation Corporation Ltd, 144 Anna Salai, NPKRR Maaligai, Chennai-600002</i>
<i>State of Registration of GSTIN</i>	<i>Tamil Nadu</i>

The TDS under GST will be recovered at applicable rate on each and every invoice of contract as per GST Act.

The appropriate rate of GST as per GST Act will be levied on Interest on SD and Security Deposit Forfeiture, if any, and amount will be recovered from the bills.

GST Details:

- a) The latest GST registration details, applicable **GST with input tax credit**, with HSN code No etc., attested by a Gazetted Officer/ Chartered Accountant/ Notary Public valid for the current year shall be enclosed along with the quotation.
- b) Appropriate rate of GST shall be admitted in lieu of (all taxes and levies replaced by GST) Excise Duty, CST and TNVAT Service Tax etc as per provisions of the rules.
- c) Any increase due to statutory variation will be admitted only when the supplies are made within the delivery schedule.
- d) In case of delayed delivery, the GST prevailing on the date of despatch or the GST on the last day of the contractual delivery period whichever is LESS will alone be admitted. For both the cases, the Supplier shall furnish documentary evidence while submitting the bills for payment.
- e) **IMPACT OF GST: Any downward variation in basic price while working due to GST and the benefit of input tax credit must be passed on to TNPGL.**
GST.1 An Overview of Goods and Services Tax [GST]:
- i). Goods and Services Tax [GST] as a modern law, has been brought after Article 366(12A) of the Constitution as amended by 101st Constitutional Amendment Act, 2016. GST is an indirect tax system, commonly used by both the Central Government and the State/UT to final consumption with credit of taxes paid at previous stages available as set off. In a nutshell, only value addition will be taxed and burden of tax Governments on goods and services. GST is a destination based tax on consumption of goods and services. It is proposed to be levied at all stages right from manufacture up is to be borne by the final consumer. GST has been rolled out w.e.f. 01.07.2017, across India.
- ii). The GST to be levied by the Centre on intra-State supply of goods and / or services would be called the Central GST (CGST) and that to be levied by the States/ Union territory would be called the State GST (SGST)/ UTGST. Similarly, Integrated GST (IGST) will be levied and administered by Centre on every inter-state supply of goods and services.
- iii). Any supplier of goods and service Provider of services who makes a taxable supply with an aggregate turnover of over Rs.20 lakhs in a financial year is required to obtain GST registration. In special category states, the aggregate turnover criteria are set at Rs.10 lakhs. In simple words every business whose taxable supply of goods or services under GST (Goods and Service Tax) and whose turnover exceeds the threshold limit of Rs. 20 lakhs / 10 Lakhs as applicable will be required to register as a normal taxable person.
- iv). GST Registration Number: TNPGL has migrated into GST regime on 15.06.2017 by duly uploading various mandatory data as required by the GST portal. The provisional ID issued to TNPGL is 33AAKCT7598K1ZI. The details are also posted in TNPGL web portal.
- v). GST Registration Number or GSTIN is 15 Digit identification number which is allotted to each applicant who applied for GST Registration. GST Number is completely based on the Pan Number and State code. First two digits represent the state code and another 10 digit represent the PAN number of the client, one digit represent the entity code (Like proprietorship or partnership etc), one digit is blank and last one is representing check digit.
- vi). Transaction Value: The value of supply of goods or services or both shall be the transaction value, which is the price actually paid or payable for the said supply of goods or services or both where the supplier and the recipient of the supply are not related and the price is the sole consideration for the supply. Sec 15(1) states that value of supply of goods and service shall be the transaction value i.e. the price actually paid or payable.
The conditions for accepting the transaction value are-
 - a) Supplier and the recipient of the supply are not related.
 - b) Price is the sole consideration for the supply.
- vii). Composition Scheme: Composition scheme specifies that registered person whose turnover in the preceding financial year is below certain specified limit (Currently RS.75 lakhs) may intimate the proper officer to pay in lieu of tax payable by him an amount calculated at such rate may be specified.

Eligibility for composition scheme: Sec10(2) of the central Goods and Services Tax Act, 2017 states that the registered person shall be eligible to opt under sub-section (1), if-

- * He is not engaged in the supply of services other than supplies referred to in clause (b) of paragraph 6 of Schedule II;
- * He is not engaged in making any supply of goods which are not leviable to tax under this Act;
- * He is not engaged in making any inter-State outward supplies of goods;
- * He is not engaged in making any supply of goods through an electronic commerce operator who is required to collect tax at source under section 52; and
- * He is not a manufacturer of such goods as may be notified by the Government on the recommendations of the Council.

viii). Supply of Service and Goods: When there is a combined supply of many goods / services, it has to be determined whether it is a Composite supply or mixed supply of goods or services

- (a) **COMPOSITE SUPPLY:** A composite supply is one where all the goods or services or a combination has to be supplied together i.e., naturally bundled and there would be a Principal Supply that could be identified (Ex. Supply of Machinery with packaging, insurance and freight – the principal supply is machinery). In this case, the rate of principal supply will be applied on entire value.
- (b) **MIXED SUPPLY:** A mixed supply is one where the goods or services or a combination thereof which could be individually supplied (like Pizza and Coke) but sold together at a single price. In this case, the highest rate to the good in that mix is applied on all the goods. The GST shall be applicable at appropriate prevailing rates as notified by GST Act. In the event of delay in execution of contract, the GST rate prevailing on the scheduled period or on the actual date of execution, whichever is less only will be admitted.

The bidders should have registered under GST Act and furnish GSTIN. In the event of contractor is within TN, SGST & CGST shall apply and if the contractor is outside TN, IGST shall apply.

GST.2 Goods and Services Tax:

- a) The Goods and Services Tax will be paid extra as applicable. The amount of CGST, SGST, and IGST as applicable shall be indicated in percentage payable and amount separately in the tender offer.
- b) The TNPGL has been registered as a dealer under GST Act 2017 (Registration No. 33AADCT4784E1ZC)

In case of delayed delivery, the GST prevailing on the date of despatch or on the last day of the contractual delivery period whichever is LESS will be admitted. For both the cases, the supplier shall furnish documentary evidence while submitting the bills for payment.

It is the responsibility of the tenderer to make sure about the correct rates of duty leviable on the material at the time of tendering. If the rates assumed by the Tenderer are less than the current rates prevailing at the time of tendering, the TNPGL Ltd will not be responsible for the mistake. If the rates assumed by the tenderer are higher than the current rates prevailing at the time of tendering, the GST prevailing at the time of tendering will only be paid.

- c) Any Variation in GST due to statutory Variation within the contract delivery date shall be considered by the TNPGL Ltd.
- d) In case of delayed delivery/delayed completion of Works, the GST prevailing on the date of dispatch or on the last day of the contractual delivery period whichever is less will be admitted.

GST.3 GST E-way bill system:-

E-Way Bill is an electronic document to be generated to cover **interstate movement** of goods value more than Rs.50,000/- and **intra-state movement** (within state of Tamil Nadu) for consignment value exceeding Rs.1,00,000/- and such generation needs to be done in **e Way Bill portal**.

Consequently, transporters of goods, are required to carry an e-Way Bill under GST provisions for the movement of such goods. The value of goods shall be the value declared in an invoice, a bill of supply or a delivery challan and also includes the Central tax, State or Union territory tax,

integrated tax and Cess charged, if any. But, it will not include value of freight charges for the movement charged by transporter.

It is the responsibility of supplier/contractor to ensure the delivery of material at TTPS stores. Therefore, it is the responsibility of supplier/contractor or their transporters to generate e-way bill before transporting goods for delivery at TNPGL's premises.

GST.4 TDS UNDER 194Q of IT Act :

Any person, being a buyer, who is responsible for paying any sum to any resident for purchase of goods of value (or) aggregate value exceeding Rs. 50 lakhs in any previous year, shall, at the time of credit of such sum to the account of the seller (or) at the time of payment, whichever is earlier shall deduct an amount equal to 0.1% of such sum exceeding Rs.50 lakhs as TDS under section- 194Q of IT Act. The supplier of goods is required to furnish PAN to TNPGL for making the payment. In case the suppliers do not have PAN, TNPGL is required to deduct TAX at a higher rate as per the provisions of Section 206AA. In case of specified person i.e., Any person who has not filed income tax return for two previous years immediately before the previous years in which TDS is required to be deducted and the time limit of filing of Income Tax return u/s 139 (1) of IT Act, 1961 as expired provided that the total TDS and TCS in INR is Rs. 50,000/- (or) more in each of the two previous years the TDS rate u/s 194Q will apply at a higher rate u/s. 206AB.

The provisions of this section shall not apply to the transactions on which tax is deductible under any other provisions of the Income Tax Act 1961 and also on the transactions in which Tax is collectible under the provisions of Section 206C.

On Purchase of goods/materials, TNPGL shall have the primary and foremost obligation to deduct Tax at source and no Tax shall be collected on such transaction u/s 206C (1H). TDS u/s 194Q is also applicable on the advance paid on the purchase of the goods.

In case of works contract wherein supply and erection portions are separable, the value of supply of goods exclusive of GST will be subject to deduction of TDS under section 194Q. On the other charges i.e. erection, testing, commissioning and maintenance charges, TDS under section 194C & 194Q will apply.

The above provisions come into effect from 01.07.2021 onwards, and hence no TCS u/s.206C (1H) has to be paid by TNPGL on purchase of Goods. Accordingly, TNPGL will deduct TDS u/s.194Q on all the purchase of goods exceeding the threshold limit i.e. aggregate credit (or) payment exceeds Rs.50 lakhs. It is mandatory for the bidder to submit a declaration format in Schedule to determine the applicability of the TDS u/s206 AB.

IT TDS is also applicable on erection and commissioning charges.

GST.5 Applicability of GST TDS:

- a) The TDS under GST will be deducted at the time of payment or accounting in the books of accounts whichever is earlier. Once the taxable value of contract exceeds Rs.2,50,000/-, then each and every invoice on that contract shall be subjected to the TDS under GST irrespective of value of such invoice.

Taxable Supply means supply of goods or services or both which is leviable to tax under GST. Thus, TDS under GST is to be deducted only on the Taxable supply of goods or services or both and not on Exempt supply (supply of any goods or services or both which attracts Nil rate of tax or which may be wholly exempt from tax under section 11 of the CGST/ SGST Acts or under section 6 of the IGST Act) and non- taxable supply. Similarly, TDS under GST rate need not be applied on GST component in the invoice. TDS under GST is also applicable for suppliers/contractors registered under composition scheme also.

- b) Where the location of the supplier and the place of supply are in the same State, it is an intra-state supply and TDS @ 1% under CGST Act and 1% under SGST Act will be deducted. Where the location of the supplier is in State A and the place of supply is in State B, it is an inter-state supply and TDS @ 2% under IGST Act will be deducted.

c) TDS under GST is also applicable in the following cases:-

- Bills of supplier for advance payment.
- Amount of retention from the bills of supplier.
- Supply of goods or services or both by supplier registered under GST as Composition dealer.

Thus Gross value of invoice (Except GST portion) shall be taken while applying TDS under GST rate.

S. No.	Location of Supplier	Location of recipient of supply of goods/services	Place of supply	GST TDS applicability
1	Tamil Nadu	Tamil Nadu (as TNPGL is in Tamil Nadu)	Tamil Nadu	Applicable (CGST TDS @1% and SGST TDS @1%)
2	State other than TN	Tamil Nadu (as TNPGL is in Tamil Nadu)	State other than TN	Not Applicable
3	State other than TN	Tamil Nadu (as TNPGL is in Tamil Nadu)	Tamil Nadu	(IGST TDS @ 2%)

d) TDS under GST is not applicable in the following cases:

1. Total value of taxable supply \leq Rs.2.5 Lakh under a contract.
2. Contract value $>$ Rs.2.5 Lakh for both taxable supply and exempted supply, but the value of taxable supply under the said contract \leq Rs.2.5 Lakh.
3. Receipt of services which are exempted. For example services exempted under notification No.12/2017 – Central Tax (Rate) dated 28.06.2017 as amended from time to time.
4. Receipt of goods which are exempted. For example goods exempted under notification No.2/2017 – Central Tax (Rate) dated 28.06.2017 as amended from time to time.
5. Goods on which GST is not leviable. For Example petrol, diesel, petroleum crude, natural gas, aviation turbine fuel (ATF) and alcohol for human consumption.
6. Where a supplier had issued an invoice for any sale of goods in respect of which tax was required to be deducted at source under the VAT Law before 01.07.2017, but where payment for such sale is made on or after 01.07.2017 [Section 142(13) refers].
7. Where the location of the supplier and place of supply is in a State(s)/UT(s) which is different from the State/ UT where the deductor is registered.
8. All activities or transactions specified in Schedule III of the CGST/SGST Acts 2017, irrespective of the value.
9. Where the payment relates to a tax invoice that has been issued before 01.10.2018.
10. Where any amount was paid in advance prior to 01.10.2018 and the tax invoice has been issued on or after 01.10.2018, to the extent of advance payment made before 01.10.2018.
11. Where the tax will be paid on reverse charge by the recipient i.e., the deductee.
12. Where the payment is made to an unregistered supplier.
13. Where the payment relates to "Cess" component.

e. Value of Supply for Deduction of TDS:

For the purpose of deduction of tax specified above, the value of supply shall be taken as the amount excluding the central tax, state tax, union territory tax, integrated tax and cess indicated in the invoice i.e., without including the amount of GST charges in the bill.

f) Exemption from TDS

According to that provision, TDS under GST need not be deducted in respect of the supply of goods and Services or both from a Public sector Undertaking (PSU) to another Public Sector Undertaking with effect from 1st day of October 2018. Therefore, no TDS need to be deducted in respect of supplies between Public sector Undertakings Example: NTECL, NTPC, BHEL etc., are owned by Central Government. However TDS provisions will continue to apply for Taxable Supplies from Government and other private agencies with effect from 01.10.2018 as already communicated vide circular 1st cited.

Public sector undertakings (PSU) means Government Companies, Government Company means any company in which not less than 51% of paid up share capital held by the Central Government or by any state Government or Governments or partly by the Central Government and

partly by one or more State Governments and includes a company which is a subsidiary of such a Government Company. This notification is with effect from 1st October 2018 itself.

GST.6 Guidelines for releasing of GST on verification of GSTR 2A

- a) The supplier/ contractor should promptly file under GST, to avoid/ minimize the delay in processing/ payment of invoices, since GSTR1 filed by the supplier/ contractor will reflect as GSTR 2A in the portal of the purchasers.
- b) If any discrepancy arises between the value shown in the GSTR-2A and the invoices available, the liability towards GST will be restricted to the lower of the two and GST payment will be made accordingly.
- c) Any lesser GST remittance found in GSTR 2A than claimed from TNPGL, the excess collection of GST will be recovered from suppliers/ contractors, duly adhering regular procedures if there is any difference between GST claimed from TNPGL and remitted to Govt. in GSTR 2A.
- d) The suppliers/ contractors whose annual turnover exceeds Rs.10 crores, should raise an e-invoice or e-invoiced debit note or e-invoiced credit note, so that TNPGL could avail input tax credit under GST. E-Invoice is a system in which B2B invoices are authenticated electronically by GSTN for further use on the common GST portal. Under the electronic invoicing system, an identification number will be issued against every invoice by the Invoice Registration Portal (IRP) to be managed by the GST Network (GSTN).**

11.0 DESPATCH INSTRUCTIONS:

The materials should be despatched as per Despatch Instructions.

12.0 PAYMENT:

Payments for the supplies will be made through NEFT/RTGS/Fund Transfer on any one of the Nationalized Banks/ Scheduled Banks approved by Reserve Bank of India, in Tamil Nadu. The Bank charges involved in making the payment will be to the account of the Tenderer.

Payments will not be made for equipments / materials damaged during transit. All defective materials shall be replaced by the supplier free of charge.

I. For the materials delivered within the contractual delivery period:

100% of all inclusive prices (including GST) of the materials of each consignment will be paid **within 45 days** from the date of receipt of materials in good condition at TTPS Stores against submission of bills with required documents after deducting recoveries, if any.

II. For the materials delivered beyond the contractual delivery period, if accepted by the purchaser:

100% of all inclusive prices (including GST) of the materials of each consignment will be paid **within 45 days** from the date of receipt of materials in good condition at TTPS Stores against submission of bills with required documents after deducting LD and other recoveries, if any.

III. For the delayed payments, if any, the simple interest shall be paid by TNPGL at the SBI three months MCLR rate for the **delayed period beyond 45 days and the rate of interest shall be as on the date of Purchase order.**

The supplier has to produce the invoice with required documents along with supply of materials to avail the above benefit. If any delay occurs in producing invoice with required documents, TNPGL will not be held any responsible for that delay.

Advance payment or payment against dispatch documents through Bank will not be accepted.

In case of delay in supply, the materials will be accepted subject to the following conditions:

- i) There should be no declining trend in prices
- ii) Payment will be released as per the latest purchase order rates or lowest rates obtained during the recent tenders opened subject to levy of liquidated damage for belated supplies.

- iii) TNPGL reserves the right to accept or reject the delayed supplies without assigning any reason therefor and take action as per the other terms and conditions of this Specification.

IV.100% payments will be made only after the approval of the test certificates and on receipt of the supplier's bills in duplicate, duly certified by the consignee. If the supplier dispatches materials without prior approval of competent authority and if any demurrage or wharfage or both are incurred by the purchaser they will be debited from the supplier.

The bills for payment will be passed only after the approval/acceptance of the following.

- 1) Security deposit cum Performance Guarantee for 5% of value of order.
- 2) copy of IT PAN/ GST Registration certificate.
- 3) Guarantee & Test Certificates
- 4) Supply of manuals, Spares as stipulated in Section – VII Technical.

The Supplier should dispatch only after getting dispatch instruction from the consignee Superintending Engineer. If the supplier dispatches the materials without the prior approval of the purchaser, then the purchaser shall not be responsible for any demurrage of wharfage or both and only the supplier should bear any expenditure arising out of such unapproved dispatches.

13.0 SECURITY DEPOSIT CUM PERFORMANCE GUARANTEE:

- 13.1. The successful tenderer will have to pay 5% value of the Purchase order (all inclusive Taxes) as combined Security Deposit cum performance guarantee in the form as follows within 15 days from the date of receipt of this Purchase order. The EMD amount if paid already, shall be deducted from the SD amount to be paid. In the event of failure to remit security deposit within 15 days, the EMD may be forfeited and the purchase order may be cancelled. If Security Deposit is paid belatedly, the same may be accepted with a penal interest at 12% per annum for the delayed period. The SD cum PG amount will not carry any interest.
 - (i) For value of Purchase order up to Rs.10 Lakhs, SD cum PG by way of cash at cash counter TTPS (if SD is less than Rs.10,000/-)/ Demand Draft / Banker's cheque / pay order or by way of NEFT / RTGS/ Account transfer to TTPS account.
 - (ii) For value of Purchase order exceeding Rs.10 Lakhs, SD cum PG in the form of Demand Draft / NEFT / RTGS / Banker's Cheque / pay order / Account transfer to TTPS account/ Irrevocable Bank Guarantee. If the SD cum PG is paid by means of Bank Guarantee, it will be accepted only after the due verification from the Banks.
- 13.2. The security Deposit cum performance Guarantee furnished shall be towards proper fulfilment of the contract as well as towards performance guarantee of the materials supplied. In case of BG, the SD cum PG shall be valid / extended for the entire period of Guarantee.
- 13.3. The Security deposit cum Performance Guarantee against this contract will be released to the contractor only if the contract is completed to the satisfaction of the purchaser.
- 13.4. The Security Deposit cum Performance Bank Guarantee will be returned to the supplier after the expiry of guarantee period after ensuring that defects/ damages during the guarantee period are rectified/ replaced to the satisfaction of the purchaser. If the purchaser incurs any loss or damages on account of breach of any of the clauses or any other amount arising out of the contract becomes payable by the supplier to the purchaser, then the purchaser will in addition to such other dues that he shall have under the law, appropriate the whole or part of the security deposit cum Performance bank guarantee and such amount that is appropriated will not be refunded to the supplier.
- 13.5. If the performance period of the supplied material is over and some quantity of within guarantee period defective material are still pending for want of repair/replacement then fresh BG equal to the cost of such defective material is to be furnished by the supplier for releasing original SD cum PBG by TNPGL (purchaser).
- 13.6 The successful tenderer will have to pay 5% of total contract value to be remitted in demand draft /NEFT/RTGS/Fund Transfer/ Banker cheque/ Bank Guarantee.

14.0. DELIVERY SCHEDULE:

1. The materials shall be supplied **WITHIN THREE MONTHS** from the date of receipt of confirmed order.
2. The contractual delivery period will not be extended. Hence all efforts shall be taken to deliver the materials within the contractual delivery period. TNPGL also reserves the right to cancel the order if the delivery schedule is not kept up, without any further notice to the supplier.
3. TNPGL Ltd reserves the right to cancel the quantities not supplied as per delivery schedule.
4. TNPGL Ltd also reserves the right to cancel the order if the delivery schedule is not kept up, without any further notice to the supplier.
5. TNPGL Ltd reserves the right to revise this delivery schedule depending on the actual requirement at the time of placing the purchase order.
6. To ensure sustained supply without any interruption, TNPGL reserves the right to place orders among more than one tenderer.
7. The TNPGL Ltd will be at liberty to cancel the contract if the supply is not made as per the delivery schedule specified in the order, notwithstanding its right to claim liquidated damages for the belated supplies and the quantity outstanding to be supplied as on the date of cancellation. The defaulting contractors will be liable to pay to the TNPGL Ltd in addition to the liquidated damages for delay, the actual difference in price whenever the TNPGL Ltd orders the delayed quantity to be supplied / executed by other agencies at higher rate.
8. The actual date of receipt of each material with all accessories at TTPS Stores will be reckoned as the date of delivery for the purpose of calculation of liquidated damages in respect of that material.
9. It is the responsibility of the supplier to give 30 days' advance information for inspection, dispatch of materials and other obligations under the terms and conditions of this contract in order to deliver the units within the contractual delivery period quoted /agreed.
10. After the issue of Despatch Instruction, if any delay is caused by the supplier in arranging timely despatches, their poor performance will be taken note of while ordering in future.

15.0. LIQUIDATED DAMAGES:

- 15.1. The delivery as specified should be guaranteed by the supplier under the liquidated damages clause given below :
- 15.2. It is the responsibility of the supplier to arrange for inspection, despatch etc. in time to keep up the delivery schedule.
- 15.3. If the supplier fails to deliver the equipments/ materials within the time specified in the order or any extension thereof, the purchaser shall recover from the supplier as liquidated damages, a sum of HALF PERCENT (0.5%) of the All inclusive price of the undelivered equipments/ Materials for each completed week of delay. The total liquidated damages shall not exceed Ten percent (10%) of the All-inclusive price of the equipments / materials so delayed. Only the date of actual receipt of materials at stores will be reckoned as date of delivery for this purpose. Liquidated damages will also be recovered for the quantity not supplied as is done for the belated supply. It is the responsibility of the suppliers to arrange for inspection, despatch etc. in time to keep up the delivery schedule.
- 15.4. It should be noted that if a contract is placed on the higher tenderer in preference to the lowest acceptable tender in consideration of the offer of earlier delivery, the said contractor will be liable to pay the TNPGL Ltd the difference between the contract rate and that of the lowest acceptable tender in case of failure to complete the supplies in terms of such contract within the delivery period specified in the tender and incorporated in the contract. This is without prejudice to other rights under the terms of contract.
- 15.5. Equipment will be deemed to have been delivered only when all its component parts and its accessories are also delivered. If certain components and accessories are not delivered in time the whole equipment will be considered as delayed unless, the missing parts are delivered.
The Liquidated damages will also be levied for the quantity not supplied as is done for the delayed supplies. If supplies effected in part could not be beneficially used by the TNPGL Ltd (due to such incomplete supply), liquidated damage will be worked out on the basis of contract price and not on the value of delayed portion only.
- 15.6. If supplies to be rendered against the rate contract are made by the supplier beyond the period of delivery stipulated in the indent and if they are accepted by the TNPGL Ltd, such acceptance is

- without prejudice to the TNPGL Ltd's rights to levy liquidated damages for the delay in supply.
- 15.7. The suppliers are liable to pay the amount of loss sustained by the TNPGL Ltd in the event of non-execution of orders, if any placed on them either in full or part to the satisfaction of the TNPGL Ltd under the terms and conditions of contract and in the event of placing orders for such quantities on some others at a higher price.
 - 15.8. Tenderer's not giving clear and specific acceptance to the above clauses is liable to be rejected.
 - 15.9. If there is any downward trend in prices on account of belated supplies, the tenderers have to accept the same with the levy of liquidated damages, for belated supplies.
 - 15.6. The defaulting suppliers will be made liable to pay to the TNPGL Ltd in addition to liquidated damages for delay, the actual difference in price, wherever TNPGL Ltd orders the delayed quantity to be supplied/executed by other agencies at a higher rate. This is without prejudice to other rights under the terms of contract.
 - 15.7. The TNPGL Ltd will also be at liberty to cancel the order if the supply is not made as per the delivery schedule specified in the order, notwithstanding its rights to claim Liquidated Damages for the belated supplies and quantity outstanding to be supplied as on the date of cancellation.
 - 15.8. The actual date of receipt of each material at TTPS Stores with all accessories will be reckoned as the date of delivery for the purpose of calculation of liquidated damages in respect of that material.
 - 15.9. The penalty, if any, will be recovered from any amount due to the contractor either in this purchase order / contract or any other Purchase Order / contract placed on him, including SD, Retention amount, Balance amount etc.

16.0. LOSS OR DAMAGE:

- 16.1. External damages or shortages that are prima facie, the results of rough handling in transit or due to defective packing will be intimated within fortnight from the date of receipt of the materials at site. Internal defects, damages or shortages of integral parts which cannot ordinarily be detected on a superficial visual examination by bad handling in transit or defective packing, would be intimated within 2 months from the date of receipt of materials. In either case, the defective materials shall be replaced/rectified by the supplier, free of cost.
- 16.2. If during the period of supply, it is found that goods already supplied are defective in material or workmanship or do not conform to specification or unsuitable for the purpose for which they are purchased, then it will be open to the purchaser either to reject the goods or repudiate the entire contract and claim such loss that the purchaser may suffer on that account require the supplier to replace the defective goods, free of cost.
- 16.3. Similarly, if during the guarantee period any of the goods found to be defective in materials or workmanship or do not conform to specification or are unsuitable for the purpose for which they are purchased, it will be open to the purchaser either to repudiate the entire contract and claim damages or accept such parts of the goods that are satisfactory and require the supplier to replace the balance or to claim compensation for the entire loss sustained by the purchaser on that account.
- 16.4. In the event of supplies being received damaged or any shortages at the destination stations, the cost of such materials, GST (if payable) and other charges payable thereof will be paid only proportionate to the value of materials received in good condition, unless the damaged goods or short supplies are made good free of cost by the suppliers.
- 16.5. For all legal purposes, the materials shall be deemed to pass into the TNPGL Ltd's ownership at the destination Stores, where they are delivered and accepted.

17.0 FORCE MAJEURE:

- 17.1. The supplier shall not be liable for delay in performing his obligations resulting directly or from any force majeure conditions herein defined as:
 - a). Any cause which is beyond the reasonable control of the supplier or purchaser as the case may be.
 - b). Natural phenomena, such as floods, drought, earthquakes and epidemics.
 - c). Act of any Govt. Authority, domestic or foreign, such as wars declared or Undeclared quarantines, embargoes licensing control on production or distribution restriction.

- d). Accident and disruptions such as fire, explosion, increase in power cut with respect to date of tender opening, break down of essential machinery or equipments etc.
- e). Strikes, slow down, and lockouts.
- f). Failure or delay in the supplier's source of supply due to force majeure causes enumerated at 'b' to 'e' above shall be considered, provided the supplier produces documentary evidence to show that there were no other alternative source of supply available to him or if available the lead time required was likely to be longer than the duration of the force majeure at the normal source of supply.

All the provisions of this clause shall apply whether the disruption cause is total or partial in its effect upon the ability of the supplier to perform.

NOTE: The cause of force majeure condition will be taken into consideration only if the supplier notifies within 15 days from the occurrence of such delay.

The purchaser shall verify the facts and grant such extension as the facts justify. For extension due to force majeure conditions, the supplier shall submit his representation with documentary evidence for scrutiny by the purchaser and decision of the purchaser shall be binding on the firm.

- 2. Provided that if the performance in whole or part by the supplier on any obligation under this contract is prevented or delayed by reasons of any eventuality for a period exceeding 60 days, the TNPGL Ltd may at its option terminate the contract by a notice in writing.
- 3. The Power cut shall not be considered under force majeure condition. The period of extension shall be decided only by the authority who placed the order, after verifying the evidence for the cause of delay.

18.0 GUARANTEE:

The equipments / materials to be supplied by you shall be guaranteed for satisfactory operation for a period of **12 months from the date of commissioning or 18 months from the date of supply whichever is later subject to an overall guarantee period of 24 months from the date of supply** under normal and proper conditions of service and maintenance. The certificate in triplicate may be enclosed with invoice or sent in advance. If during the above period any of the equipment / materials supplied by you are found defective in materials or workmanship, the same shall be rectified or replaced by you at destination free of charge. The defective equipment / material will have to be taken back at your own cost and risk.

- 3. The tenderers shall guarantee among other things, the following:
 - i) Quality and Strength of materials used.
 - ii) Safe electrical and mechanical stresses on all parts of the equipments/ materials under all specified conditions.
 - iii) Performance figures given by the tenderers in the Schedule of Guaranteed technical particulars.

19.0 REPLACEMENT OF DEFECTIVE / DAMAGED MATERIALS:

- 19.1. Notwithstanding anything contained in the above liquidated damages clause when the whole or part of the materials supplied by the supplier are found to be defective/damaged or are not in conformity with the specification or sample, such defects or damages in the materials supplied shall be rectified within two months from the date of intimation of defect/damage either at the point of destination or at the supplier's works, at the cost of supplier, against proper security and acknowledgment. In the alternative, the defective or damaged materials shall be replaced free of cost within two months from the date of receipt of the intimation from the purchaser of such defects or damages. If the defects or damages are not rectified or replaced within this period, the supplier shall pay a sum towards liquidated damages at the rate of (0.5%) half percent value (all inclusive price of such material for each completed week of delay subject to maximum of (10%) Ten percent for the delay from the date of receipt of intimation of the defects or damages.
- 19.2. In the event of supplies being received damaged or short at the destination stores, the cost of such materials will be paid only proportionate, to the value of the materials received in good condition unless the damaged goods or short supplies are made good free of cost to the TNPGL Ltd by the supplier.

- 19.3. If during the period of supply, it is found that goods already supplied are defective in materials or workmanship or do not conform to the Specification or are unsuitable for the purpose for which they are purchased then it will be open to the purchaser either to reject the goods or repudiate the entire contract and claim such loss that the purchaser may suffer on the account or require the contractor to replace the defective goods free of cost.
- 19.4. Similarly, if during the guarantee period stipulated under Guarantee clause subsequent to the date of receipt of the goods, any of the goods be found defective in materials or workmanship, or do not conform to the rate contract or are unsuitable will be open to the purchaser either to repudiate the entire contract and claim damages or accept such part of the goods that are satisfactory and required the contractor to replace the balance or pay compensation to the extent of the loss sustained by the purchase on that account.
- 19.5 Notwithstanding any other remedies available, the purchaser shall be entertained to dispose off the defective / damaged materials in "as is where is condition" without further notice, if the contractor / supplier fails to rectify the defect and / or replace the damaged materials and / or fails to remove defective/ damaged materials within two months period as per PO terms, from the date of receipt of intimation from the purchaser, TNPGL Ltd reserves right to dispose of such materials. This is without prejudice to the imposition of Liquidated Damages, Ground rent, forfeiture of security deposit etc.,

20.0 INSURANCE:

Contracting firms shall arrange insurance for the equipment/materials and all its accessories being supplied by them, through any of the Nationalised Insurance Companies. The equipment/materials shall be insured to cover transport (from Warehouse) and 60 days storage risk at site. The damages, if any, during transit will be reported within 30 days of receipt of materials. It will be the responsibility of the supplier to replace the defective/damaged materials and make good the shortages and other losses in transit, free of cost, lodge and recover claim from Insurance, Under writers/Carriers.

21.0. PACKING AND FORWARDING:

The packing shall conform to relevant packing standards. The contractor should however, ensure that the packing is such that the materials reach their destination without damage/loss during transit by Rail or Road and subsequent storage. The words "Handle with care" should be printed on the cartons.

The equipment/materials and all its accessories shall be securely packed and despatched, freight paid, duly insured, at supplier's risk and cost. The packing may be in accordance with the manufacturer's standard practice. The supplier is responsible for ascertaining the facilities that exist for Road Transport to site. Each package shall be clearly marked and contain detailed packing list, such as gross weight, net weight etc. The supplier is solely responsible for any loss or damage during transport. The despatch of materials shall be made only after the approval of routine test certificates by the TNPGL Ltd. The equipment/ Materials shall be unloaded at Destination Stores/Sites by the supplier at free of cost.

22.0 FAILURE TO EXECUTE THE CONTRACT:

Suppliers falling to execute the order placed on them to the satisfaction of the TNPGL Ltd under the terms and conditions set-forth therein, will be liable to make good the loss sustained by the TNPGL Ltd, consequent to the placing of fresh orders elsewhere at higher rate, i.e. the difference between the price accepted in the contract already entered into and the price at which fresh orders have been placed. This is without prejudice to the imposition of penalty under the Liquidated Damages clause and forfeiture of security deposit etc.,

23.0. NON-ASSIGNMENT:

The supplier shall not assign or transfer the contract or any part thereof without the prior approval of the Purchaser

24.0. EFFECTING OF RECOVERIES:

Any loss, arising due to non-fulfilment of this contract or any other contract, will be recovered from the Security Deposit held and / or any other amount due to the supplier from the TNPGL Ltd from this Contract as well as from other contracts.

25.0. PATENT RIGHTS ETC:

The supplier shall indemnify the purchaser against all claims, actions, suits and proceedings for the infringement or alleged infringement of any patent, design or copy right protected either in the country of origin or in India by the use of any equipment supplied by the supplier other than for the purpose indicated by or reasonably to be inferred from the specification.

26.0. JURISDICTION FOR LEGAL PROCEEDINGS (AFTER AWARD OF CONTRACT):

No suit or any proceedings in regard to any matter arising in respect of this contract shall be instituted in any court, save in Madras the High Court, Madurai Bench or District Court at Tuticorin or Sub-Court at Tuticorin or at the District Munsif Court at Tuticorin. It is agreed that no other court shall have jurisdiction to entertain any suit or proceedings even though, part of the cause of action might arise within the jurisdiction. In case any part of the cause of action might arise within the jurisdiction of any other courts in Tamil Nadu and rest within the jurisdiction of courts outside the state of Tamil Nadu, then it is agreed to between the parties that such suits or proceedings shall be instituted in a court within the state of Tamil Nadu and no other court outside the state of Tamil Nadu shall have jurisdiction even though any part of the cause of action might arise within the jurisdiction of such courts. The successful tenderer shall furnish an undertaking as per schedule in non-judicial stamp paper of Rs.500/- agreeing to the above condition.

27.0. ARBITRATION ACT NOT TO APPLY:

The TNPGL Ltd will not accept any arbitration in case of disputes arising in any respect under this contract. Any dispute arising out of this contract shall not be subject to arbitration under the provisions of Arbitration and Conciliation Act 1996 in the event of any dispute between the parties.

28.0. TEST AT SITE:

The purchaser reserves the rights of having such tests or may decide up on being carried out at site at his own expenses to satisfy himself that the materials have not suffered any damage during transit.

29.0. RESPONSIBILITY:

The Tenderer is responsible for delivery of the materials at the destination station in good condition. The tenderer shall include and provide for securely protecting and packing the materials as per relevant packing standards to avoid damages or loss in transit. All risks connected with the supply of these materials should be borne by the supplier.

30.0. MAXIMUM WEIGHTS AND DIMENSIONS OF PACKING :

The supplier is responsible to make sure about the facilities that exist for Road and Rail transport to site, the maximum packages which can be conveyed by the railways and crane lift available at the destination railway station. The supplier is also responsible for any loss or damage during transport and storage for 60 days.

Each case or package should be clearly marked and should contain detailed packing list.

31.0 INSPECTION:

- 31.1. The authorized representatives of the purchaser shall have access to the supplier's or sub-vendor's works at any time during working hours, for the purpose of inspecting the manufacture of the materials and for testing the selected samples from the materials covered by this specification. The supplier or the sub-vendor shall provide facilities for the above.
- 31.2. Tenderers are requested to furnish in their tenders the exact location of their factory with detailed address to enable inspection by TNPGL Ltd if considered necessary.
- 31.3. Not less than 15 days advance intimation shall be given about the quantity of materials that will be ready for inspection to the TNPGL Ltd's Officers. The arrangement for inspection shall be made by supplier in such a way that the delivery schedule is kept up. The materials shall not be despatched without instruction from TNPGL Ltd.
- 31.4. Factory inspection will be done by the TNPGL Ltd's officers to assess the genuineness in manufacturing the tendered materials and to assess whether the firm have infrastructural facilities to manufacture the same.

32.0. COMPLETENESS OF TENDER:

32.1 The tender should be complete with all details of illustrative and descriptive literature and drawings. The tenderers shall furnish the complete technical details of the equipment/materials. Information regarding the country of manufacture or origin of materials used in the manufacture of the articles should be furnished. The tenderer should include all minor accessories even though not specifically mentioned in this specification but which are essential for the completeness of the materials ordered. The tenderer shall not be eligible for extra charges in respect of such minor accessories though not included in the tender.

33.0. INTERCHANGEABILITY:

33.1 All similar parts and removable parts of similar items shall be interchangeable with each other.

34.0. ELECTRICITY RULES:

34.1 All works shall be carried out in accordance with the latest provisions of the Indian Electricity Act/Electricity Supply Act and the Indian Electricity Rules there-under unless modified by this specification.

35.0. MATERIALS AND WORKMANSHIP:

35.1. All materials, equipments and spare parts thereof shall be new, unused and originally coming from manufacturers' plant to the destination stores. Those including used, rebuilt or overhauled materials/equipments will not be accepted.

35.2. All the materials shall be of best class and capable of satisfactory operation in the tropics with humid atmospheric condition. Unless otherwise specified, they shall conform to the requirements of appropriate India Standards. Where these are not available, IEC and American / British Standards shall be followed.

35.3. The design shall incorporate every reasonable precautions and provisions for the safety of all those concerned in the operation and maintenance of equipment/ materials.

35.4. The materials should be designed to facilitate inspection and repair and to ensure satisfactory operation under atmospheric conditions prevailing at site and under sudden variations of and voltages as may be met with under working conditions in the system including those due to faulty synchronizing and short circuits within the rating of the apparatus.

35.5. The design shall incorporate every reasonable precautions and provisions for the safety of all those concerned in the operation and maintenance of equipment.

35.6. All the equipments should operate without undue vibration and with the least practicable amount of noise.

36.0. RECOVERY OF DUES:

36.1. The TNPGL Ltd is empowered:

- a). To recover any dues against this contract in any bills/ Security Deposit/ Earnest Money Deposit due to the suppliers either in this contract or any other contract with TNPGL Ltd.
- b). To recover any dues against any other contracts of the suppliers with TNPGL Ltd, with the available amount due to the supplier against this contract.

37.0. CLIMATIC CONDITIONS:

The materials are for use in T.T.P.S, Tamil Nadu and should be satisfactory for operation under tropical conditions in Tuticorin.

- a. The ambient temperature will be within the range of +10°C to +50°C
- b. Maximum atmospheric humidity will be in the range of 95%.
- c. Average number of thunder storm days per annum is 65.
- d. Average number of dust storm days per annum is 5.
- e. Average number of rainy days per annum is 65.
- f. Average annual rainfall is 10.00 cm.
- g. Climatic conditions are prone to wide variation in ambient condition and equipments offered under this specification shall be suitable for installation at the Sub-Station in TTPS or other P.H.
- h. All electrical devices shall be given tropical and fungicidal treatment. Fog, smoke and mild acids are also present in the atmosphere.

38.0. RAW MATERIALS:

38.1 It is the responsibility of the tenderer to make his own arrangement to procure the necessary raw materials required for the manufacture.

38.0. RAW MATERIALS:

38.1 It is the responsibility of the tenderer to make his own arrangement to procure the necessary raw materials required for the manufacture.

39.0 TEST CERTIFICATES:

Every item of equipment / materials to be supplied by you shall be tested in accordance with the relevant Indian, British or continental standards. Wherever no standards are available test shall be conducted according to manufacturer's standard practice. The test results issued by Government Lab / Government approved Lab / NABL accredited Lab / Manufacturer in triplicate has to be forwarded to the Superintending Engineer/ P&A Tuticorin Thermal Power Station, Tuticorin – 628 004 for scrutiny and approval.

In addition to the tests called for in the specification, the purchaser reserves the right of having such tests as he desires carried out at his own expenses to satisfy himself that the materials confirm to the requirements of this specification.

The materials may be rejected if the test results are not satisfactory.

SPECIFICATION NO. CE / TTPS - 4135-S / 2025-26

SECTION – VI – FORMATS

SCHEDULE-A

PRICE BID

(Price to be quoted in BOQ Excel Sheet by downloading and the same should be uploaded)

Name of Work:

Sl. No	Description	Qty.	Unit Price in Rs.				FOR (D) ** PRICE IN Rs.
			Ex-Works	*P&F in (percentage)	F*I in (percentage)	GST in (percentage)	Unit Total (including P&F, F&I and applicable GST)
1.	Supply of ECO Hopper Ash Disposal Pipe Lines & Fittings for Unit - V with all dimensions and material as per drawing enclosed. Spool piece-size:250 NB, length-310mm, thick-12mm with 2 Nos Flanges	1 No	To be quoted on-line in BOQ				
2.	Spool piece-size:250 NB, length-955mm, thick-12mm with 2 Nos Flanges	1 No	To be quoted on-line in BOQ				
3.	Spool piece-size:250 NB, length-1085mm, thick-12mm with 2 Nos Flanges	1 No	To be quoted on-line in BOQ				
4.	Spool piece-size:250 NB, length-5130mm, thick-12mm with 2 Nos Flanges	1 No	To be quoted on-line in BOQ				
5.	Unequal Tee Size:250/200 NB TEE, length 855/100mm, thick-12mm with 3 Nos Flanges	1 No	To be quoted on-line in BOQ				
6.	Unequal Tee Size:250/200 NB TEE, length1300/100mm, thick-12mm with 3 Nos Flanges	3 Nos	To be quoted on-line in BOQ				
7.	90°Bend-Size:250 NB, mean length -350mm, thick-12mm with 2 Nos flanges	3 Nos	To be quoted on-line in BOQ				
8	90°Bend-Size:250 NB, mean length -450mm, thick-12mm with 2 Nos flanges	2 Nos	To be quoted on-line in BOQ				
9	90°Bend-Size:250 NB, mean length -500mm, thick-12mm with 2 Nos flanges	1 No	To be quoted on-line in BOQ				
10	90°Bend-Size:250 NB, mean length -650mm, thick-12mm with 2 Nos flanges	1 No	To be quoted on-line in BOQ				

11	Unequal Tee Size:500/250 NB, length 1030/105mm, thick-12mm with 3 Nos Flanges	1 No	To be quoted on-line in BOQ
12	Reducer Size:500/250 NB, length 500mm, thick-12mm with 2 Nos Flanges	1 No	To be quoted on-line in BOQ
13	Reducer Size:250/100 NB, length 260mm, thick-12mm with 2 Nos Flanges	1 No	To be quoted on-line in BOQ
14	MS Bolt & Nut, Washer for M16x110	200 Kg	To be quoted on-line in BOQ
15	MS Bolt & Nut, Washer for M20 x 100	30 Kg	To be quoted on-line in BOQ
16	Neoprene Rubber gasket Size : 1Mtr X 2 Mtr 5mm thick	100 Kg	To be quoted on-line in BOQ

Company Seal:

Signature :
Designation :
Company :
Date :

NOTE:

- 1) The all inclusive price shall be considered for evaluation of bidders. The all inclusive price shall include (Ex works price + P&F+ Freight and Insurance) + GST + any other charges (if any)
- 2) The evaluation will be done only based on the GST rates quoted by the bidders.
- 3) While quoting the rates the bidder shall indicate the HSN Code (Harmonized System Nomenclature code) for all the tendered items as per GST Act.

*P&F – Packing and Forwarding; F*I – Freight and Insurance;

** For supply at the Destination stores at TTPS/Tuticorin in Tamil Nadu.

SCHEDULE-B
SCHEDULE OF MATERIALS AND DELIVERY PERIOD
(To be filled in by the Tenderer)

Sl.No.	Description	Qty.	Delivery Period
			From the Date of Receipt of Purchase Order.

Company Seal:

Signature :
Designation :
Company :
Date :

SCHEDULE – 'C-1'
DEVIATION FROM TECHNICAL SPECIFICATION

All Technical Deviation from the Specification shall be filled in by the Tenderer, Clause by Clause, in the Schedule.

SECTION NO.	CLAUSE NO.	DEVIATION

The tenderer hereby certify that the above mentioned are the only deviations from the technical Specifications and confirms to the specification in all other aspects.

Company Seal:

Signature :
Designation :
Company :
Date :

SCHEDULE – 'C2'
DEVIATION FROM COMMERCIAL SPECIFICATION

All Deviations from the Commercial terms shall be filled in by the Tenderer, Clause by Clause, in this Schedule.

SECTION NO.	CLAUSE NO.	DEVIATION

The tenderer hereby certify that the above mentioned are the only deviations from the Commercial terms of the Specification.

Company Seal:

Signature :
Designation :
Company :
Date :

SCHEDULE-D

STATEMENT OF SUPPLY ORDERS - EXECUTED / UNDER EXECUTION DURING THE PAST THREE YEARS AS ON THE DATE OF TENDER

NAME OF EQUIPMENT / MATERIAL:

Sl. No.	Name & Address of the Organization	PO No. & Date	Qty.	Value of Order in Rs. Lakhs	Schedule Date of Completion of Order.	Actual Date of Completion of Order.
1	2	3	4	5	6	7

Company Seal:

Signature :
Designation :
Company :
Date :

SPECIFICATION NO. CE / TTPS – 4135-S /2025-26

SCHEDULE – E

DECLARATION FORM

(To be signed by the tenderer)

Strike off, whichever is not applicable:

To
The Chief Engineer,
Tuticorin Thermal Power Station,
Tamil Nadu Power Generation Corporation Ltd,
Tuticorin - 628004, Tamil Nadu

Dear Sir,

Having examined the above specification together with the accompanying schedules etc., we hereby offer to manufacture and supply the equipments/ materials covered in this Specification at the rates entered in the attached schedule of prices.

1. We hereby guarantee the particulars entered in the schedules attached to the Specification.
2. In accordance with the Security Deposit cum Performance guarantee clause-9.0, Section-V, of the specification, we agree to furnish security deposit cum performance Guarantee to the extent of 5% of the Contract value (All-inclusive price) of each and every indent issued during the contract period till the expiry of the Guarantee.
3. Our company is not a potentially Sick Industrial Company or a Sick Industrial Company in terms of Section-23 of Section-15 of the Sick Industrial Companies (Special Provisions) Act, 1985.

Yours faithfully,

PLACE	:	SIGNATURE	:
DATE	:	DESIGNATION	:
COMPANY SEAL	:	COMPANY	:

SCHEDULE-F

UNDERTAKING FOR PAYMENT OF DUES TO TNEB

THIS DEED OF UNDERTAKING EXECUTED AT..... ON THIS
THE.....DAY OF..... (MONTH) TWO THOUSAND TWENTY FIVE
BY M/s.

Hereinafter called the "TENDERER" (Which expression where the context so admits mean and include their agents, representatives, Successors – in – office and Assigns)

TO AND IN FAVOUR OF..... THE TAMIL NADU POWER GENERATION CORPORATION LIMITED, a Body Corporate, incorporated under Companies Act 1956, having its office at TTPS, Tuticorin-628004, herein called the "TNPGL" (which expression shall where the context so admits mean and include its successors in office and Assigns.)

WHEREAS the Board has called for an undertaking from the Tenderer empowering the Board to recover the dues if any.

NOW THIS UNDERTAKING WITNESSETH that the Board is empowered to recover any dues against this contract in any bills / Security Deposit / E.M.D. due to the Tenderer either in this contract or any other contracts with the Board. Further, the Tenderer hereby authorizes the Board to recover, any dues against any other contract of the Tenderer with the Board with the available amount due to the Tenderer against this contract.

IN WITNESS WHERE OF Thiru.....Acting for and behalf of the Tenderer has signed this deed on the day, month and year herein before first mentioned.

SIGNATURE OF THE TENDERER.

NAME :
DESIGNATION :
DATE :
COMPANY SEAL :

SCHEDULE-G

UNDERTAKING IN LIEU OF E.M.D.

(To be furnished in non-judicial stamp paper of value not less than Rs.500/-)

THIS DEED OF UNDERTAKING EXECUTED AT..... ON THIS THE.....DAY OF..... (MONTH) TWO THOUSAND TWENTY FIVE BY M/s. Hereafter called "Tenderer" (Which expression shall where the context so admits mean and include their Agents, Representatives, Successors-in-office and Assigns).

TO AND IN FAVOUR OF..... THE TAMIL NADU GENERATION AND DISTRIBUTION CORPORATION LIMITED, a Body Corporate, incorporated under Companies Act 1956, having its office at TTPS, Tuticorin-628004, herein called the "TNPGL" (which expression shall where the context so admits mean and include its successors in office and Assigns.)

WHEREAS THE tenderer is required to pay Earnest Money Deposit of Rs..... for participation in the tender for supply of in terms of Specification No.

AND WHEREAS the tenderer is exempted by the TNPGL from payment of EMD in the form of cash, subject to the tenderer executing an undertaking to the value of Rs..... (Rupees.....) representing the amount equivalent to the amount of EMD specified to be paid to the TNPGL in the event of non-fulfilment of breach of any of the conditions of the tender by the Tenderer as mentioned hereunder.

AND WHEREAS in consideration of the acceptance by the TNPGL of the above proposal, the Tenderer has agreed to pay to the TNPGL the said amount of Rs..... in the event of:

- 1) Withdrawing his tender before the expiry of validity Period (OR)
- 2) Withdrawing his tender after acceptance (OR)
- 3) Violating any of the conditions of the tender issued by the competent Authority

NOW THIS UNDERTAKING WITNESSES that in pursuance of the said agreement the Tenderer hereby doth convenient with the TNPGL that in consideration of the "TNPGL" waiving the condition of payment of EMD in cash in terms of the said Specification, the Tenderer has agreed to pay to the TNPGL Rs..... (Rupeesonly) in the event of:

- i) Withdrawing his tender before the expiry of validity period.
- ii) Withdrawing his tender after acceptance
- iii) Violating any of the conditions of the tender issued by the Competent Authority.

NOW THE CONDITION OF THE above written undertaking is such that if the tenderer shall duly and faithfully observe and perform the conditions specified as above, then the above written undertaking shall be void, otherwise it shall remain in full force.

The tenderer undertakes not to revoke this guarantee till the contract is completed under the terms of contract.

The expression, `tenderer' and the ` TNPGL ' hereinafter before used shall include their respective successors and assign in office.

IN WITNESS WHEREOF THIRU.....
acting for and on behalf of the Tenderer has signed this deed on the day, month and year herein before first mentioned.

SIGNATURE
NAME IN BLOCK LETTERS
SEAL OF THE COMPANY

IN THE PRESENCE OF WITNESSES:

1) Signature
Name & Address

2) Signature
Name & Address

*** **

SCHEDULE-H

UNDERTAKING TOWARDS JURISDICTION OF LEGAL PROCEEDINGS

This undertaking executed at on this..... (Date)..... (Month) TWO THOUSAND TWENTY FIVE by M/s. Registered under Companies Act, 1956 having its registered office at hereinafter called the contractor (which expression shall where the context so admits mean and include its successors in office and in favour of Tamil Nadu Generation and Distribution Corporation Limited, a Body Corporate, incorporated under Companies Act 1956, having its registered Office at No.144, Anna Salai, NPKRR Maaligai, Chennai - 600 002 herein after called the Purchaser (Which expression shall where the context so admits means and includes its successors in Office and assigns).

WHEREAS a contract for the supply of..... has been awarded in favour of the contractor under the Purchase Order No. Dated.....

AND WHEREAS in accordance with terms of the above mentioned Purchase Order, the contractor has to furnish an undertaking to the effect that no suit or any proceedings in regard to any matter arising in any respect under this contract shall be instituted in any court other than in the Madras High Court, Madurai Bench or District Court at Tuticorin or Sub-court at Tuticorin or at the District Munsif Court at Tuticorin as the case may be.

IN CONSIDERATION of the TNPGL having agreed to accept the undertaking the contractor hereby undertakes that no suit or any proceedings in regard to any matter arising in respect of this contract shall be instituted in any Court, save in the Madras High Court, Madurai Bench or District Court at Tuticorin or Sub-Court at Tuticorin. Or at the District Munsif Court at TUTICORIN as the case may be. It is agreed that no other court shall have jurisdiction to entertain any suit or proceedings, even though, part of the cause of action might arise within their jurisdiction. In case any part of the cause of action might arise within the jurisdiction of any other Courts in Tamil Nadu, and rest within the jurisdiction of Courts outside the State of Tamil Nadu, then it is agreed to between the parties that such suits on proceedings shall be instituted in a Court within the State of Tamilnadu and no other Court outside the State of Tamil Nadu shall have jurisdiction.

IN WITNESS WHERE OF Thiru..... of M/s..... hereby put his hand and seal for due observance of the Undertaking in the presence of the following witnesses.

COMPANY SEAL:

SIGNATURE :
DESIGNATION :
COMPANY :
DATE :

WITNESSES:

- 1)
- 2)

SCHEDULE-I

TENDER ACCEPTANCE LETTER (e – tender)

To be signed with company seal on letter head and uploaded in the technical Bid

TENDER ACCEPTANCE LETTER (To be given on Company Letter Head)

Date:

To

The Chief Engineer,
Tuticorin Thermal Power Station,
Tamil Nadu Generation and Distribution Corporation,
Tuticorin - 628004, Tamil Nadu.

Dear Sir,

Sub: Acceptance of Terms & Conditions of Tender.

Tender Ref. No: **4135 -S, Opening Due on 17.04.2026**

Name of Tender/Work: **Supply of ECO Hopper Ash Disposal Pipe Lines & Fittings for Unit - V**

1. I/We have downloaded / obtained the tender document(s) for the above mentioned 'Tender/Work' from the web site(s) namely:
As per your advertisement, given in the above mentioned website(s).
2. I/We hereby certify that I/We have read the entire terms and conditions of the tender documents from page No.----- to -----(including all documents like annexure(s), schedule(s), etc.,) which form part of the contract agreement and I/We shall abide hereby the terms / conditions / clauses contained therein.
3. The corrigendum(s) issued from time to time by your department/ organization too has also been taken into consideration, while submitting this acceptance letter.
4. I/We hereby unconditionally accept the tender conditions of above mentioned tender document(s) corrigendum(s) in its totality / entirety.
5. We hereby guarantee the particulars entered in the schedules attached to the Specification.
6. In accordance with the Security cum Performance guarantee clause-9.0, Section-V, of the specification, we agree to furnish security cum performance guarantee to the extent of 5% of the contract value (All-inclusive price) valid till the expiry of the Guarantee.
7. Our company is not a potentially Sick Industrial Company or a Sick Industrial Company in terms of Section-23 of Section-15 of the Sick Industrial Companies (Special Provisions) Act, 1985.
8. In case any provisions of this tender are found violated, then your department/organization shall without prejudice to any other right or remedy be at liberty to reject this tender/bid including the forfeiture of the full said earnest money deposit absolutely.

Yours Faithfully,

(Signature of the bidder, with official Seal)

SCHEDULE-J

Declaration to be submitted by the L1 bidder in Non Judicial Stamp Paper of value not less than Rs.500/-

To

Date :

The Chief Engineer,
Tuticorin Thermal Power Station,
Tuticorin – 4.

We hereby declare and confirm that we are registered vendor under GST Act having GSTIN _____ in State of _____. Our applicable GST @ _____ % **Extra** / GST @ _____ % **Inclusive** against this **Tender specification No. / Enquiry No _____, dt. _____** is under HSN / SAC code _____.

We hereby declare and confirm that we are registered vendor under composite scheme having GSTIN.

We are aware that as per Sec 171 of CGST Act, any reduction in rate of tax on any supply of goods or services or the benefit of input tax credit should be passed on to TANGEDCO by way of commensurate reduction in prices and as such we hereby declare that we are extending of _____% as rebate in my awarded price against input tax credit benefit.

(OR)

We hereby declare that we do not have any input tax credit benefit on account of GST applicable against this **Tender specification No. / Enquiry No _____, dt. _____**. If it is established that we have availed input tax credit benefit against this job, the differential tax benefit will be returned to TANGEDCO failing which TANGEDCO may take appropriate action.

Signature of bidder with Company Seal

Note :

1. Each page should be signed.
2. Bidder may strike out the para not applicable.

SCHEDULE-K

BANK GUARANTEE FOR EMD

(B.G for EMD shall be executed on Non judicial stamp paper of Rs. 500/-)

Beneficiary:-----

Date:-----

Bid Guarantee No:_____

We have been informed that (insert name of bidder) (herein after called „the bidder“) has submitted to you its bid dated (insert date) (herein after called „the bid“) for the execution of Supply of ECO Hopper Ash Disposal Pipe Lines & Fittings for Unit - V at Tuticorin Thermal Power Station, Thoothukudi Dist., Tamil Nadu.

Furthermore, we understand that, according to your conditions, bids must be supported by a bid guarantee.

At the request of the bidder, we (name of the Bank) hereby irrevocably undertake to pay you any sum or sums not exceeding in total an amount of (amount in figures)_____(amount in words) _____ upon receipt by us of your first demand in writing accompanied by a written statement stating that the bidder is in breach of its obligation(s) under the bid conditions ,because the Bidder:

- a) has withdrawn its bid during the period of bid validity specified by the Bidder in the Form of Bid; (or)
- b) having been notified of the acceptance of its Bid by the Employer during the period of validity (i) fails or refuses to execute the Contract Form, if required, or ii) fails or refuses to furnish the Performance Security, in accordance with the Instructions to Bidders.

This guarantee will expire:(a) if the bidder is the successful Bidder, upon our receipt of copies of the contract signed by the Bidder and the Performance Security issued to upon the instruction of the Bidder and (b) if the bidder is not successful Bidder, upon the earlier of (i) our receipt of copy of your notification to the Bidder of the name of the successful Bidder; or (ii) twenty eight days after the expiration of the Bidder’s Bid.

Consequently, any demand for payment under this guarantee must be received by us at the office on or before that date.

This guarantee is subject to the Uniform Rules for Demand Guarantees, ICC publication No 758.

Signature

With seal of the Bank
(Name in block letter)

In the presence of witness:

1 . (Name in capital and address)

2 . (Name in capital and address)

**TAMIL NADU GENERATION AND DISTRIBUTION CORPORATION LIMITED
TUTICORIN THERMAL POWER STATION
SPECIFICATION NO: CE/TTPS -4135-S/2025-26**

SECTION-VII

TECHNICAL SPECIFICATION

(To be signed with company seal on letter head and should be uploaded along with drawing, if drawing is required)

DESCRIPTION OF MATERIAL:

SI. No	Description	Qty
	Supply of ECO Hopper Ash Disposal Pipe Lines & Fittings for Unit - V with all dimensions and material as per drawing enclosed.	
1	Spool piece-size:250 NB, length-310mm, thick-12mm with 2 Nos Flanges	1 No
2	Spool piece-size:250 NB, length-955mm, thick-12mm with 2 Nos Flanges	1 No
3	Spool piece-size:250 NB, length-1085mm, thick-12mm with 2 Nos Flanges	1 No
4	Spool piece-size:250 NB, length-5130mm, thick-12mm with 2 Nos Flanges	1 No
5	Unequal Tee Size:250/200 NB TEE, length 855/100mm, thick-12mm with 3 Nos Flanges	1 No
6	Unequal Tee Size:250/200 NB TEE, length1300/100mm, thick-12mm with 3 Nos Flanges	3 Nos
7	90°Bend-Size:250 NB, mean length -350mm, thick-12mm with 2 Nos flanges	3 Nos
8	90°Bend-Size:250 NB, mean length -450mm, thick-12mm with 2 Nos flanges	2 Nos
9	90°Bend-Size:250 NB, mean length -500mm, thick-12mm with 2 Nos flanges	1 No
10	90°Bend-Size:250 NB, mean length -650mm, thick-12mm with 2 Nos flanges	1 No
11	Unequal Tee Size:500/250 NB, length 1030/105mm, thick-12mm with 3 Nos Flanges	1 No
12	Reducer Size:500/250 NB, length 500mm, thick-12mm with 2 Nos Flanges	1 No
13	Reducer Size:250/100 NB, length 260mm, thick-12mm with 2 Nos Flanges	1 No
14	MS Bolt & Nut, Washer for M16x110	200 Kg
15	MS Bolt & Nut, Washer for M20 x 100	30 Kg
16	Neoprene Rubber gasket Size : 1Mtr X 2 Mtr 5mm thick	100 Kg

Encl : Drawing – 4 Nos

**CHIEF ENGINEER,
T.T.P.S./TUTICORIN-4.**

250 NB SPOOL PIECE
Material SS 316 gr

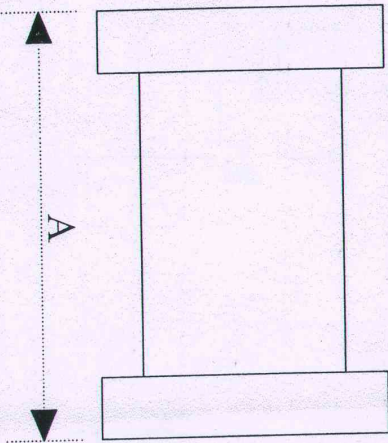

Item no	A	Qty
1	250	1
2	300	1
3	310	1
4	955	1

Item no	A	Qty
5	1085	1
6	1560	1
7	1850	1
8	2070	1

Item no	A	Qty
9	2230	1
10	2270	1
11	3660	1
12	3700	1

Item no	A	Qty
13	3900	1
14	4820	1
15	5000	1
16	5100	1
17	5130	1

FLANGE DETAILS

	OD	ID	PCD	NO OF HOLE	HOLE DIA	FLANGE THK
FLANGE 250 NB	420	274	360	12 No's	18	25

TUTTICORIN THERMAL POWER STATION
ECO HOPPER ASH DISPOSAL PIPE LINE
AND FITTINGS LAYOUT - UNIT - V

NAME/DSGN _____ SIGNATURE _____

JE/AHP _____
DATE 5-31-14

AE/AHP _____
DATE 02/03/14

HE/AHP _____
DATE 02/03/14

DRAWING NOT TO SCALE
ALL DIMENSIONS ARE IN MM

250 / 200 NB UNEQUAL TEE
Material SS 316 gr

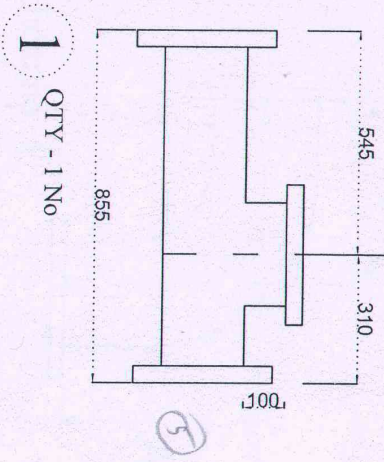

1 QTY - 1 No

250 / 200 NB UNEQUAL TEE
Material SS 316 gr

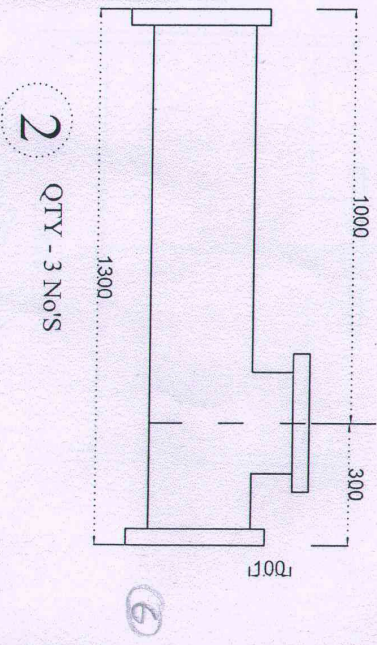

2 QTY - 3 No'S

500 / 250 NB REDUCER
Material SS 316 gr

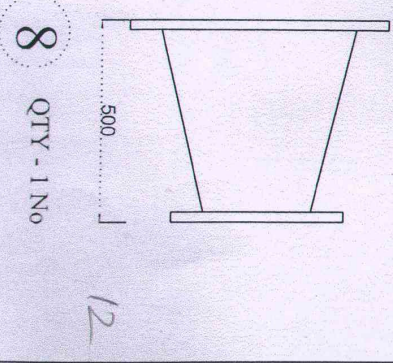

8 QTY - 1 No

Material SS 316 gr

FLANGE DETAILS

	OD	ID	PCD	NO OF HOLE	HOLE DIA	FLANGE THK
FLANGE 250 NB	420	274	360	12 No's	18	25
FLANGE 500 NB	715	508	620	20 No's	25	44
FLANGE 200 NB	360	220	296	8 No's	18	25

TUTICORIN THERMAL POWER STATION ECO HOPPER ASH DISPOSAL PIPE LINE AND FITTINGS LAYOUT - UNIT - V	
NAME/DSGN	SIGNATURE
JE/AHP	<i>S. Rajasekar</i>
AEE/AHP	<i>[Signature]</i>
EE/AHP	<i>K. Murugan</i>
DRAWING NOT TO SCALE ALL DIMENSIONS ARE IN MM	

250 NB 90° Bend

Material SS 316 gr

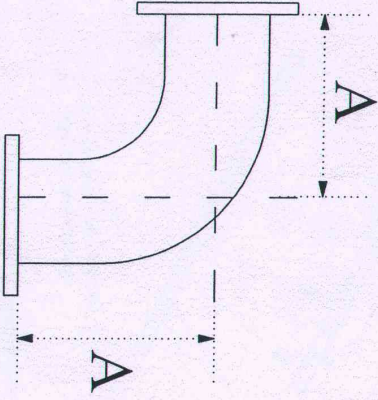

Item no A

- 3 350 - 3 No's -7
- 4 450 - 4 No's -8
- 5 650 - 1 No -10
- 6 500 - 1 No -9

FLANGE DETAILS

	OD	ID	PCD	NO OF HOLE	HOLE DIA	FLANGE THK
FLANGE 250 NB	420	274	360	12 No's	18	25
FLANGE 300 NB	715	508	620	20 No's	25	44
FLANGE 100 NB	265	117	192	8 No's	18	20

500 / 250 EQUAL TEE

Material SS 316 gr

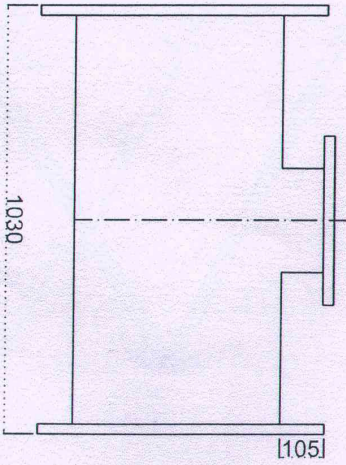

7 Qty - 1 No

250 / 100 NB REDUCER

Material SS 316 gr

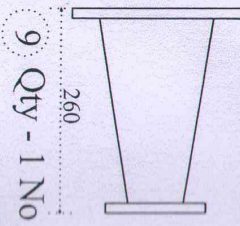

9 Qty - 1 No

TUTICORIN THERMAL POWER STATION	
ECO HOPPER ASH DISPOSAL PIPE LINE	
AND FITTINGS LAYOUT - UNIT - V	
N. SIVEDSON	SIGNATURE
JU/AHP	
AEB/AHP	
EH/HP?	
DRAWING NOT TO SCALE	
ALL DIMENSIONS ARE IN MM	

S. S. Sivasankar
R. Murugesan

ECO HOPPER ASH DISPOSAL PIPE LINE AND FITTINGS LAYOUT - UNIT - V

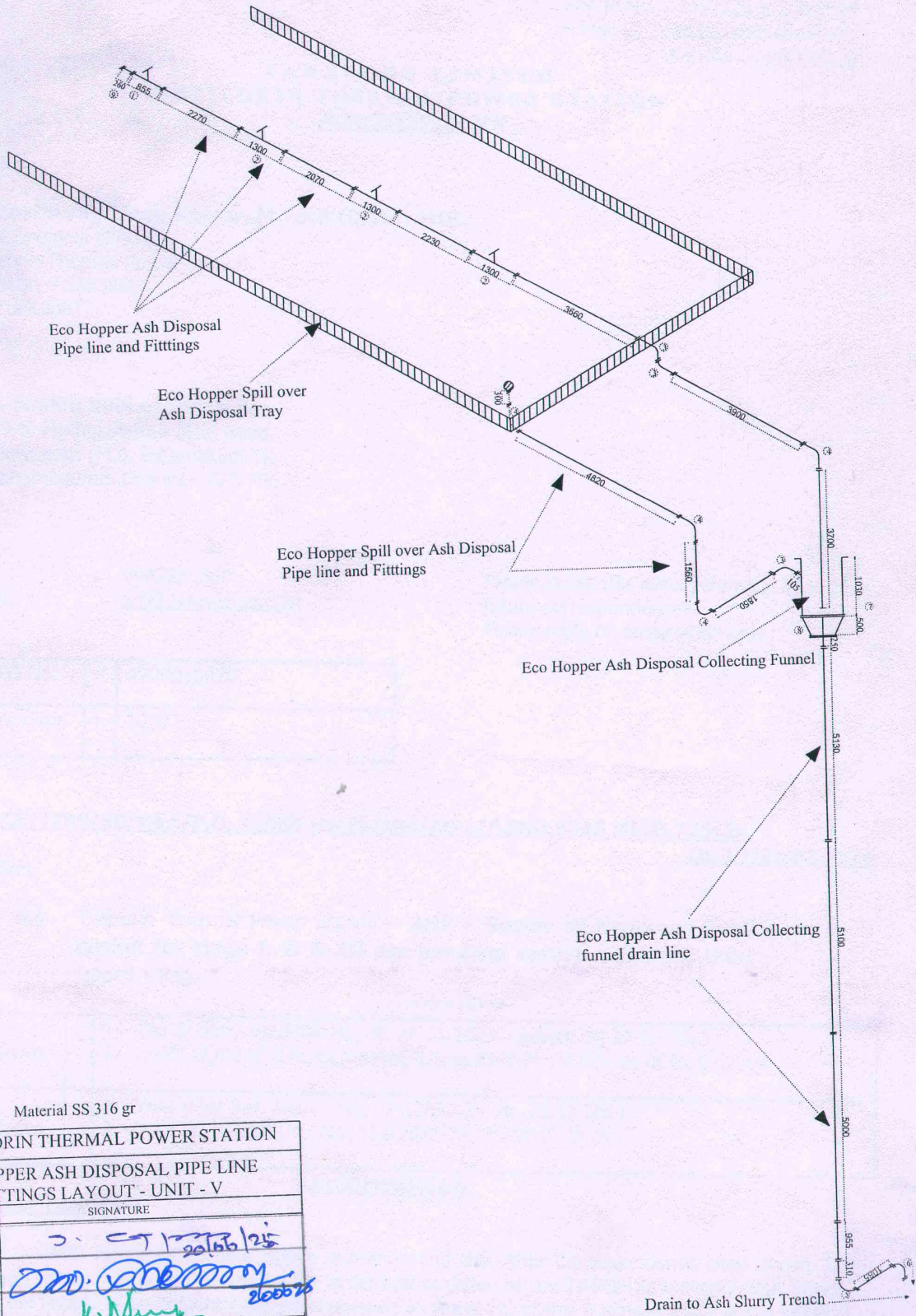

Material SS 316 gr

TUTICORIN THERMAL POWER STATION	
ECO HOPPER ASH DISPOSAL PIPE LINE AND FITTINGS LAYOUT - UNIT - V	
NAME/DSGN	SIGNATURE
JE/AHP	<i>[Signature]</i> 20/06/25
AEE/AHP	<i>[Signature]</i> 20/06/25
EE/AHP	<i>[Signature]</i> 20/06/25
DRAWING NOT TO SCALE ALL DIMENSIONS ARE IN MM	